

Series PROFITEST MASTER

PROFITEST MBASE+, MTECH+, MPRO, MXTRA, SECULIFE IP

Test Instruments for IEC 60364 / DIN VDE 0100

3-349-647-03
15/7.16



Test Instrument and Adapter

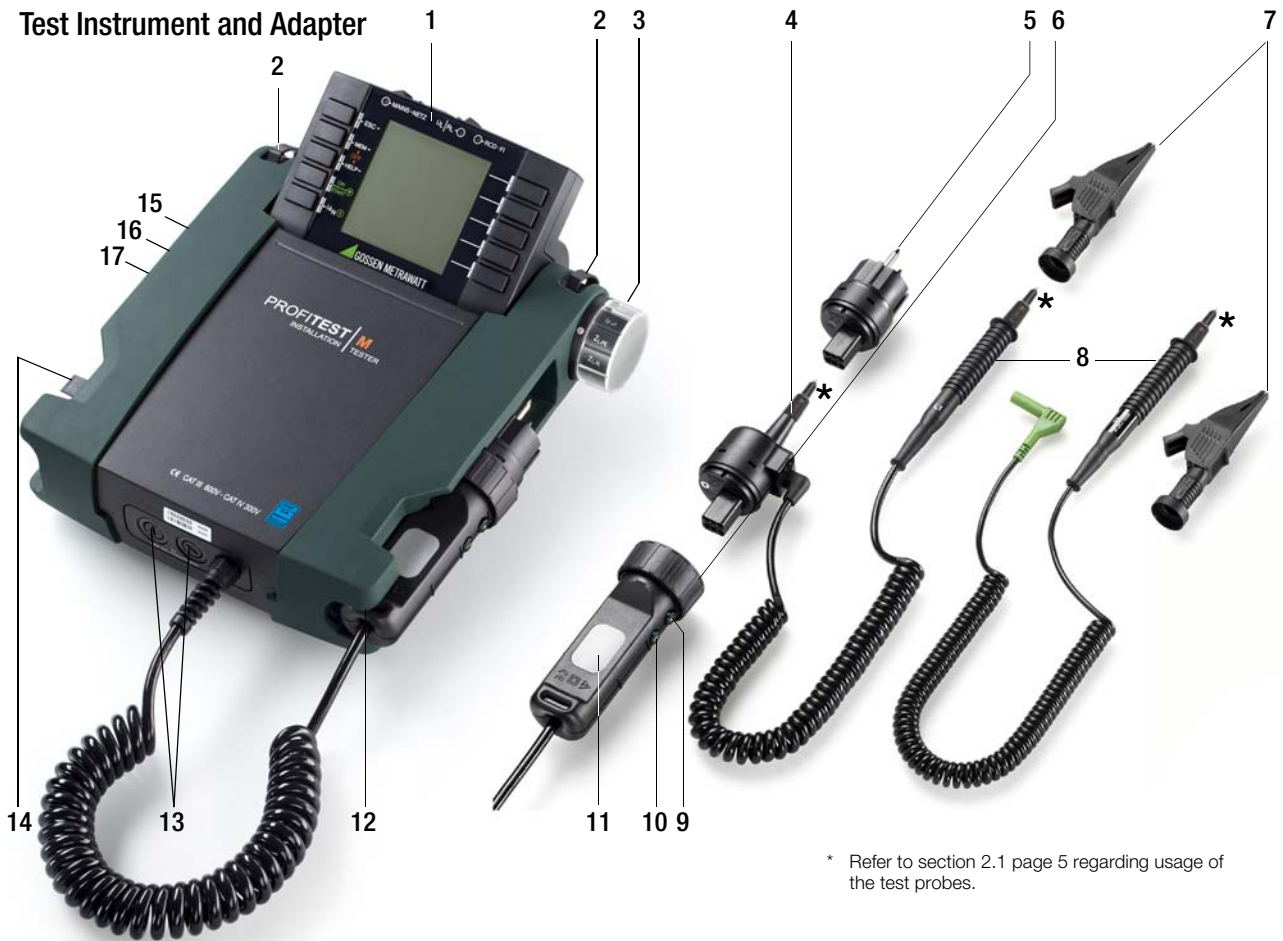

* Refer to section 2.1 page 5 regarding usage of the test probes.

Control Panel

LEDs and connection icons → section 18

Fixed Function Keys

ESC:	Return to submenu
MEM:	Key for memory functions
HELP:	Access context sensitive help
ON/START:	Switch instrument on, start/stop measurement
I _{ΔN} :	Tripping test Proceeding to next function (semi-automatic measurement) Start offset measurements

Softkeys

- Parameter selection
- Specify limit value
- Entry functions
- Memory functions

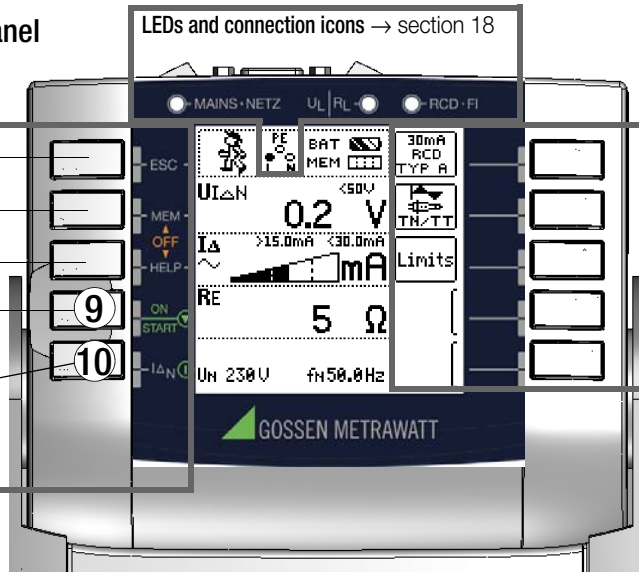

Sockets for Current Clamp Sensor, Probe and PRO-AB Leakage Current Adapter

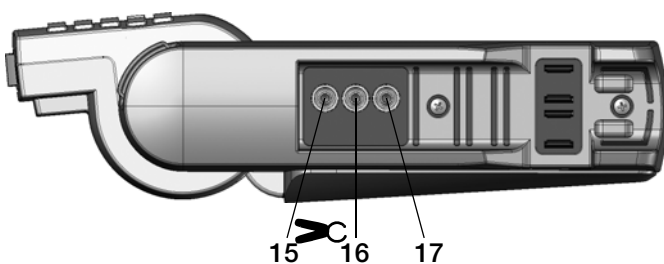

Interfaces, Charger Jack

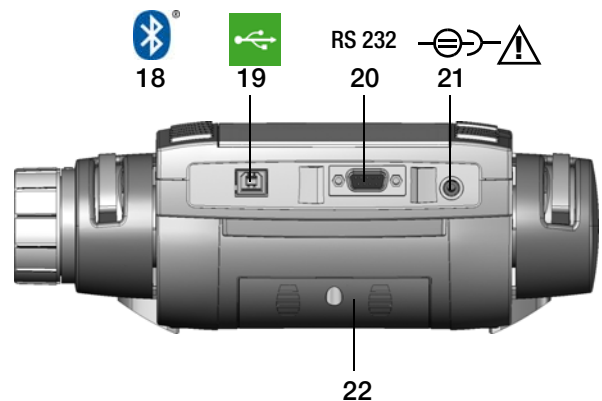

Key

Test Instrument and Adapter

- 1 Control panel with keys and display panel with detent for ideal viewing angle
- 2 Eyelets for attaching the shoulder strap
- 3 Rotary selector switch
- 4 Measuring adapter (2-pole)
- 5 Plug insert (country specific)
- 6 Test plug (with retainer ring)
- 7 Alligator clip (plug-on)
- 8 Test probes
- 9 ▼ key **ON/START** *
- 10 I key $I_{\Delta N}/compens./Z_{OFFSET}$
- 11 Contact surfaces for finger contact
- 12 Test plug holder
- 13 Fuses
- 14 Holder for test probes (8)

Connections for Current Clamp, Probe and PRO-AB Adapter

- 15 Current clamp connection 1
 - 16 Current clamp connection 2
 - 17 Probe connection
- ### Interfaces, Charger Jack
- 18 *Bluetooth*[®]
 - 19 USB slave for PC connection
 - 20 RS 232 for connecting barcode scanner or RFID reader
 - 21 Jack for Z502P charger
 - 22 Battery Compartment Lid (compartment for batteries and replacement fuses)

Attention! Make sure that no batteries are inserted before connecting the charger.

Please refer to section 17 for explanations regarding control and display elements.

* Can only be switched on with the key on the instrument

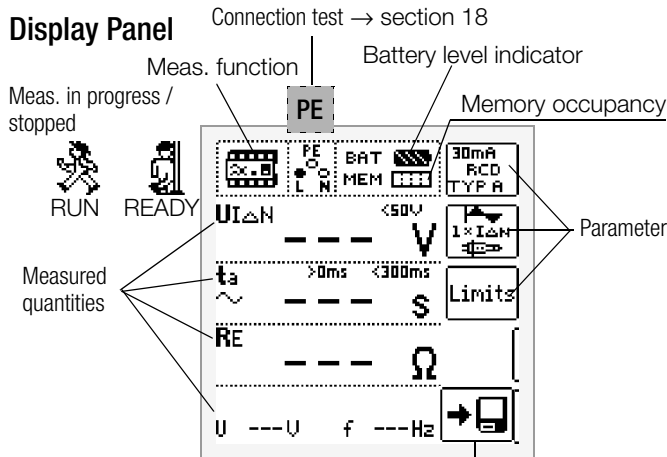

Bluetooth[®] active:

Battery level indicator

- BAT Battery full BAT Battery weak
- BAT Battery OK BAT Battery (nearly) depleted: $U < 8 V$

Memory occupancy display

- MEM Memory full > transfer data to PC
- MEM Memory half full

Connection Test – Mains Connection Test (→ section 18)

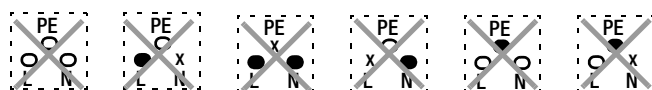

These operating instructions describe a tester with software version SW-VERSION (SW1) 01.16.00

Overview of Device Settings and Measuring Functions

Switch Setting, Descr. on	Picto-graph	Device Settings	Measuring Functions
SETUP page 8		SETTING Brightness, contrast, time/date, <i>Bluetooth</i> [®] Language (D, GB, P), profiles (ETC, PS3, PC.doc) Default settings TESTS Rotary switch balancing, battery test >	
Measurements with line voltage U page 16		Single-phase measurement U_{L-N-PE} UL-N Voltage between L and N UL-PE Voltage between L and PE UN-PE Voltage between N and PE US-PE Voltage between probe and PE f Frequency 3-phase measurement U_{3-} UL3-L1 Voltage between L3 and L1 UL1-L2 Voltage between L1 and L2 UL2-L3 Voltage between L2 and L3 f Frequency Phase sequence	
Appears for all meas. shown below:		U / U_N Line voltage / nominal line voltage f / f_N Line frequency / nominal line frequency	
$I_{\Delta N}$ page 18		$U_{\Delta N}$ Contact voltage t_a Tripping time RE Earth resistance	
IF Δ page 20		$I_{\Delta N}$ Contact voltage I_{Δ} Residual current RE Earth resistance	
ZL-PE page 26		ZL-PE Loop impedance IK Short-circuit current	
ZL-N page 28		ZL-N Line impedance IK Short-circuit current	
RE page 30		2-P 2-pole measurement (ground loop) RE(L-PE) 2-P 2-pole measurement with country spec. plug 3-P 3-pole measurement (2-pole with probe) SEL 3-P Selective meas. with current clamp sensor UE Earth electrode voltage (probe/clamp)	
Measurements at voltage-free objects RE (MPRO) (MXTRA) page 37		3-P 3-pole measurement 4-P 4-pole measurement SEL 3-P Selective measurement with current clamp sensor 2-CL 2-clamp measurement (earth loop res.) SE ρ_E Soil resistivity ρ_E	
RLO page 47		RLO Low-resistance with polarity reversal RLO+, RLO- Low-resistance, single-pole Roffset Offset resistance	
RISO RINS page 44		RINS Insulation resistance RE(INS) Earth leakage resistance U Voltage at the test probes UINS Test voltage Ramp: triggering/breakdown voltage	
SENSOR page 50		I_L/AMP Residual or leakage current T/RF Temperature/humidity (in preparation)	
EXTRA page 51		ΔU Voltage drop measurement ZST Standing surface insulation impedance kWh-Test Meter start-up test, earth contact plug I_L^1 Leakage current meas. with Z502S adapter IMD Check insulation monitoring device U_{res}^2 Residual voltage test $t_a + \Delta t^2$ Intelligent ramp RCM ² RCM (residual current monitor) $e-mobility^3$ Electric vehicles at charging stations (IEC 61851) PRCD ² Testing of PRCDs type S and K	
AUTO page 64		Automatic test sequences	

¹ only MXTRA & SECULIFE IP ² only MXTRA ³ only MTECH+ & MXTRA

1	Scope of delivery	5	10	Earthing Resistance Measurement (R_E function)	30
2	Applications	5	10.1	Earthing Resistance Measurement – Mains Operated	31
2.1	Using Cable Sets and Test Probes	5	10.2	Earthing Resistance Measurement – Battery Powered (only MPRO & MXTRA)	31
2.2	Overview of Features Included with PROFITEST MASTER & SECULIFE IP Device Variants	6	10.3	Earthing Resistance, Mains Powered – 2-Pole Measurement with 2- Pole Adapter or Country-Specific Plug (Schuko) without Probe ...	32
3	Safety Features and Precautions	6	10.4	Earthing Resistance Measurement, Mains Powered – 3-Pole Mea- surement: 2-Pole Adapter with Probe	33
4	Initial Start-Up	7	10.5	Earthing Resistance Measurement, Mains Powered – Measure- ment of Earth Electrode Voltage (U_E function)	34
4.1	Preparation for use	7	10.6	Earthing Resistance Measurement, Mains Powered – Selective Earthing Resistance Measurement with Current Clamp Sensor as Accessory	35
4.2	Installing or Replacing the Battery Pack	7	10.7	Earthing Resistance Measurement, Battery Operated – 3-Pole (only MPRO & MXTRA)	37
4.3	Switching the Instrument On/Off	7	10.8	Earthing Resistance Measurement, Battery Operated – 4-Pole (only MPRO & MXTRA)	38
4.4	Battery Test	7	10.9	Earthing Resistance Measurement, Battery Operated – Selective (4-pole) with Current Clamp Sensor and PRO-RE Measuring Adap- ter as Accessory (only MPRO & MXTRA)	40
4.5	Charging the Battery Pack in the Tester	7	10.10	Earthing Resistance Measurement, Battery Powered – Ground Loop Measurement (with current clamp sensor and transformer, plus PRO- RE/2 measuring adapter as accessory) (only MPRO & MXTRA)	41
4.6	Device Settings	8	10.11	Earthing Resistance Measurement, Battery Powered – Measurement of Soil Resistivity ρ_E (only MPRO & MXTRA)	42
5	General Notes	13	11	Measuring Insulation Resistance	44
5.1	Connecting the Instrument	13	11.1	General	44
5.2	Automatic Settings, Monitoring and Shut-Off	13	11.2	Special Case: Earth Leakage Resistance (R_{EISO})	46
5.3	Measurement Value Display and Memory	13	12	Measuring Low-Value Resistance up to 200 Ohm (protective conductor and equipotential bonding conductor)	47
5.4	Testing Earthing Contact Sockets for Correct Connection	13	12.1	Measurements with Constant Test Current	48
5.5	Help Function	14	12.2	Protective Conductor Resistance Measurement with Ramp Curve – Measurements on PRCDs with Current-monitored Protective Conductor Using PROFITEST PRCD Test Adapter as Accessory	49
5.6	Setting Parameters or Limit Values using RCD Measurement as an Example	14	13	Measurement with Accessory Sensors	50
5.7	Freely Selectable Parameter Settings or Limit Values	15	13.1	Current Measurement with Current Clamp Sensor	50
5.8	2-Pole Measurement with Fast or Semiautomatic Polarity Reversal ...	15	14	Special Functions – EXTRA Switch Position	51
6	Measuring Voltage and Frequency	16	14.1	Voltage Drop Measurement (at ZLN) – ΔU Function	52
6.1	Single-Phase Measurement	16	14.2	Measuring the Impedance of Insulating Floors and Walls (standing surface insulation impedance) – Z_{ST} Function	53
6.1.1	Voltage Between L and N (U_{L-N}), L and PE (U_{L-PE}) and N and PE (U_{N-PE}) with Country-Specific Plug Insert, e.g. SCHUKO	16	14.3	Testing Meter Start-Up with Earthing Contact Plug – kWh Function (not SECULIFE IP)	54
6.1.2	Voltage between L – PE, N – PE and L – L with 2-Pole Adapter Connection	16	14.4	Leakage Current Measurement with PRO-AB Leakage Current Adapter as Accessory – I_L Function (PROFITEST MXTRA & SECULIFE IP only)	55
6.2	3-Phase Measurement (line-to-line voltage) and Phase Sequence	17	14.5	Testing of Insulation Monitoring Devices – IMD Function (PROFITEST MXTRA & SECULIFE IP only)	56
7	Testing RCDs	17	14.6	Residual Voltage Test – Ures Function (PROFITEST MXTRA only)	58
7.1	Measuring Contact Voltage (with reference to nominal residual current) with $1/3$ Nominal Residual Current and Tripping Test with Nominal Residual Current	18	14.7	Intelligent Ramp – ta+ID Function (PROFITEST MXTRA only)	59
7.2	Special Testing for Systems and RCCBs	20	14.7.1	Applications	59
7.2.1	Testing Systems and RCCBs with Rising Residual Current (AC) for Type AC, A/F, B/B+ and EV/MI RCDs	20	14.8	Testing Residual Current Monitors – RCM Function (PROFITEST MXTRA only)	60
7.2.2	Testing Systems and RCCBs with Rising Residual Current (AC) for Type B/B+ and EV/MI RCDs (nur MTECH+, MXTRA & SECULIFE IP)	20	14.9	Testing the Operating States of Electric Vehicles at Charging Sta- tions per IEC 61851 (MTECH+ & MXTRA only)	61
7.2.3	Testing RCCBs with $5 \cdot I_{\Delta N}$	21	14.10	Test Sequences for Report Generation of Fault Simulations on PRCDs with PROFITEST PRCD Adapter (MXTRA only)	62
7.2.4	Testing of RCCBs which are Suited for Pulsating DC Residual Current	21	14.10.1	Selecting the PRCD under Test	62
7.3	Testing for Special RCDs	22	14.10.2	Parameter Settings	62
7.3.1	System, Type RCD-S Selective RCCBs	22	14.10.3	Test Sequence PRCD-S (single phase) – 11 Test Steps	63
7.3.2	PRCDs with Non-Linear Type PRCD-K Elements	22	14.10.4	Test Sequence PRCD-S (three-phase) – 18 Test Steps	63
7.3.3	SRCD, PRCD-S (SCHUKOMAT, SIDOS or comparable)	23	15	Automatic Test Sequences – AUTO Function	64
7.3.4	Type G or R RCCB	24	16	Database	66
7.4	Testing Residual Current Circuit Breakers in TN-S Systems	25			
7.5	Testing of RCD Protection in IT Systems with High Cable Capa- cittance (e.g. in Norway)	25			
8	Testing of Breaking Requirements Overcurrent Protective Devices, Measurement of Loop Impedance and Determination of Short-Circuit Current (functions Z_{L-PE} and I_k)	26			
8.1	Measurements with Suppression of RCD Tripping	26			
8.1.1	Measurement with Positive Half-Waves (only MTECH+/MXTRA/SECULIFE IP)	27			
8.2	Evaluation of Measured Values	27			
8.3	Settings for Short-circuit current Calculation – Parameter I_k	28			
9	Measuring Line Impedance (Z_{L-N} function)	28			

16.1	Creating Distributor Structures, General	66
16.2	Transferring Distributor Structures	66
16.3	Creating a Distributor Structure in the Test Instrument	66
16.3.1	Creating Structures (example for electrical circuit)	67
16.3.2	Searching for Structural Elements	68
16.4	Saving Data and Generating Reports	69
16.4.1	Use of Barcode Scanners and RFID Readers	70
17	Operating and Display Elements	71
18	LED Indications, Mains Connections and Potential Differences	73
19	Characteristic Values	82
20	Maintenance	87
20.1	Firmware Revision and Calibration Information	87
20.2	Rechargeable Battery Operation, and Charging	87
20.2.1	Charging Procedure with Charger for Z502R	87
20.3	Fuses	87
20.4	Housing	87
21	Appendix	88
21.1	Tables for the determination of maximum or minimum display values under consideration of maximum measuring uncertainty:	88
21.2	At which values should/must an RCD actually be tripped? Requirements for Residual Current Devices (RCDs)	90
21.3	Testing Electrical Machines per DIN EN 60204 – Applications, Limit Values	91
21.4	Periodic Testing per DGUV provision 3 (previously BGV A3) – Limit Values for Electrical Systems and Operating Equipment	92
21.5	List of Abbreviations and their Meanings	93
21.6	Keyword Index	94
21.7	Bibliography	95
21.7.1	Internet Addresses for Additional Information	95
22	Repair and Replacement Parts Service Calibration Center and Rental Instrument Service	96
23	Recalibration	96
24	Product Support	96

1 Scope of delivery

- 1 Test instrument
- 1 Earthing contact plug insert (country-specific)
- 1 2-pole measuring adapter and 1 cable for expansion into a 3-pole adapter (PRO-A3-II)
- 2 Alligator clips
- 1 Shoulder strap
- 1 Compact Master Battery Pack (Z502H)
- 1 Charger Z502R
- 1 DAkkS calibration certificate
- 1 USB cable
- 1 Condensed operating instructions
- 1 Supplement Safety Information
- Detailed operating instructions for download from our website at www.gossenmetrawatt.com

2 Applications

This instrument fulfills the requirements of the applicable EU guidelines and national regulations. We confirm this with the CE marking. The relevant declaration of conformity can be obtained from GMC-I Messtechnik GmbH.

The **PROFITEST MASTER** and **SECULIFE IP** measuring and test instruments allow for quick and efficient testing of protective measures in accordance with DIN VDE 0100, part 600:2008 (Erection of low-voltage installations; tests – initial tests), as well as ÖVE-EN 1 (Austria), NIV/NIN SEV 1000 (Switzerland) and other country-spe-

cific regulations.

The test instrument is equipped with a microprocessor and complies with IEC 61557/DIN EN 61557/VDE 0413 regulations:

- Part 1: General requirements
- Part 2: Insulation resistance
- Part 3: Loop resistance
- Part 4: Resistance of earth connection and equipotential bonding
- Part 5: Earth resistance
- Part 6: Effectiveness of residual current devices (RCD) in TT, TN and IT systems
- Part 7: Phase sequence
- Part 10: Electrical safety in low-voltage systems up to 1000 V AC and 1500 V DC – Equipment for testing, measuring or monitoring of protective measures
- Part 11: Effectiveness of type A and type B residual current monitors (RCMs) in TT, TN and IT systems

The test instrument is especially well suited for:

- System setup
- Initial start-up
- Periodic testing
- Troubleshooting in electrical systems

All of the values required for approval reports (e.g. for ZVEH) can be measured with this instrument.

All acquired data can be archived, in addition to the measurement and test reports which can be printed out at a PC. This is of special significance where product liability is concerned.

The applications range of the test instruments covers all alternating and three-phase current systems with nominal voltages of 230 V / 400 V (300 V / 500 V) and nominal frequencies of 16²/₃ / 50 / 60 / 200 / 400 Hz.

The following can be measured and tested with the instruments:

- Voltage / frequency / phase sequence
- Loop impedance / line impedance
- Residual current devices (RCDs)
- Insulation monitoring devices (IMDs) (only **MXTRA** & **SECULIFE IP**)
- Residual current monitoring devices (RCMs) (only **MXTRA**)
- Earthing resistance / earth electrode potential
- Standing surface insulation resistance / insulation resistance
- Earth leakage resistance
- Low-value resistance (potential equalization)
- Leakage currents with current transformer clamp
- Residual voltage (only **MXTRA**)
- Voltage drop
- Leakage current with leakage current adapter
- Meter start-up (not **SECULIFE IP**)
- Cable length

Refer to section 21.3 regarding testing of electrical machines in accordance with DIN EN 60204.

Refer to section 21.4 regarding periodic testing in accordance with DGUV provision 3 (previously BGV A3).

2.1 Using Cable Sets and Test Probes

- 2 or 3-pole measuring adapter included
- 2-pole measuring adapter with 10 m cable as optional accessory: PRO-RLO II (Z501P)
- KS24 cable set as optional accessory (GTZ3201000R0001)

Measurements per DIN EN 61010-031 may only be performed in environments in accordance with measuring categories III and IV with the safety cap attached to the test probe at the end of the measurement cable.

In order to establish contact inside 4 mm jacks, the safety caps have to be removed by prying open the snap fastener with a pointed object (e.g. the other test probe).

2.2 Overview of Features Included with PROFITEST MASTER & SECULIFE IP Device Variants

PROFITEST ... (Article Number)	M <small>BASE+</small> (M520S)	M <small>PRO</small> (M520N)	M <small>TECH+</small> (M520R)	M <small>XTRA</small> (M520P)	SECULIFE IP (M520U)
Testing of residual current devices (RCDs)					
U _B measurement without tripping RCD	✓	✓	✓	✓	✓
Tripping time measurement	✓	✓	✓	✓	✓
Measurement of tripping current I _F	✓	✓	✓	✓	✓
Selective, SRCDS, PRCDS, type G/R	✓	✓	✓	✓	✓
AC/DC sensitive RCDs, type B, B+ and EV/MI	—	—	✓	✓	✓
Testing of IMDs	—	—	—	✓	✓
Testing of RCMS	—	—	—	✓	—
Testing for N-PE reversal	✓	✓	✓	✓	✓
Measurement of loop impedance Z_{L-PE} / Z_{L-N}					
Fuse table for systems without RCDs	✓	✓	✓	✓	✓
Without tripping the RCD, fuse table	—	—	✓	✓	✓
With 15 mA test current ¹ without tripping the RCD	✓	✓	✓	✓	✓
Earthing resistance R_E (mains operation)					
I-U measuring method (2/3-wire measuring method via measuring adapter: 2-wire/2-wire + probe)	✓	✓	✓	✓	✓
Earthing resistance R_E (battery operation)					
3 or 4-wire measurement via PRO-RE adapter	—	✓	—	✓	—
Soil resistivity ρ_E (battery operation)					
(4-wire measurement via PRO-RE adapter)	—	✓	—	✓	—
Selective earthing resistance R_E (mains operation)					
with 2-pole adapter, probe, earth electrode and current clamp sensor (3-wire measuring method)	✓	✓	✓	✓	✓
Selective earthing resistance R_E (battery operation)					
with probe, earth electrode and current clamp sensor (4-wire measuring method via PRO-RE adapter and current clamp sensor)	—	✓	—	✓	—
Earth loop resistance R_{ELOOP} (battery operation)					
with 2 clamps (current clamp sensor direct and current clamp transformer via PRO-RE/2 adapter)	—	✓	—	✓	—
Measurement of equipotential bonding R_{LO}, automatic polarity reversal					
	✓	✓	✓	✓	✓
Insulation resistance R_{INS}, variable or rising test voltage (ramp)					
	✓	✓	✓	✓	✓
Voltage U_{L-N} / U_{L-PE} / U_{N-PE} / f					
	✓	✓	✓	✓	✓
Special measurements					
Leakage current (with clamp) I _L , I _{AMP}	✓	✓	✓	✓	✓
Phase sequence	✓	✓	✓	✓	✓
Earth leakage resistance R _{E(ISO)}	✓	✓	✓	✓	✓
Voltage drop (ΔU)	✓	✓	✓	✓	✓
Standing-surface insulation Z _{ST}	✓	✓	✓	✓	✓
Meter start-up (kWh-Test)	✓	✓	✓	✓	—
Leakage current with PRO-AB adapter (IL)	—	—	—	✓	✓
Residual voltage test (U _{res})	—	—	—	✓	—
Intelligent ramp (ta + ΔI)	—	—	—	✓	—
Electric vehicles at charging stations (IEC 61851)	—	—	✓	✓	—
Report generation of fault simulations on PRCDS with PROFITEST PRCD adapter	—	—	—	✓	—
Features					
Selectable user interface language ²	✓	✓	✓	✓	✓
Memory (database for up to 50,000 objects)	✓	✓	✓	✓	✓
Automatic test sequence function	✓ ²	✓	✓	✓	✓
RS 232 port for RFID/barcode scanner	✓	✓	✓	✓	✓
USB port for data transmission	✓	✓	✓	✓	✓
Interface for Bluetooth®	—	—	—	✓	✓
ETC user software for PC	✓	✓	✓	✓	✓
Measuring category: CAT III 600 V / CAT IV 300 V	✓	✓	✓	✓	✓
DAkkS calibration	✓	✓	✓	✓	✓

¹ The so-called live measurement is only advisable if there is no bias current within the system. Only suitable for motor circuit breaker with low nominal current

² currently available languages: D, GB, I, F, E, P, NL, S, N, FIN, CZ, PL

3 Safety Features and Precautions

This instrument fulfills all requirements of applicable European and national EC directives. We confirm this with the CE mark. The relevant declaration of conformity can be obtained from GMC-I Messtechnik GmbH.

The electronic measuring and test instrument is manufactured and tested in accordance with safety regulations IEC 61010-1/DIN EN 61010-1/VDE 0411-1 and EN 61557.

Safety of the operator, as well as that of the instrument, is only assured when it is used for its intended purpose.

Read the operating instructions thoroughly and carefully before using your instrument. Follow all instructions contained therein. Make sure that the operating instructions are available to all users of the instrument.

Tests may only be executed by a qualified electrician.

Grip and hold the test plug and test probes securely when they have been inserted, for example, into a socket. Danger of injury exists if tugging at the coil cord occurs, which may cause the test plug or test probes to snap back.

The measuring and test instrument may not be placed into service:

- If the battery compartment lid has been removed
- If external damage is apparent
- If connector cable or measuring adapters are damaged
- If the instrument no longer functions flawlessly
- After a long period of storage under unfavorable conditions (e.g. humidity, dust, temperature)

Exclusion of Liability

When testing systems with RCCBs, the latter may switch off. This may occur even though the test does not normally provide for it. Leakage currents may be present which, in combination with the test current of the test instrument, exceed the shutdown threshold value of the RCCB. PCs which are operated in proximity to such RCCB systems may switch off as a consequence. This may result in inadvertent loss of data. Before conducting tests, precautions should therefore be taken to ensure that all data and programs are adequately saved, and the computer should be switched off if necessary. The manufacturer of the test instrument assumes no liability for any direct or indirect damage to equipment, computers, peripheral equipment or data bases when performing tests.

Opening of Equipment / Repair





The equipment may be opened only by authorized service personnel to ensure the safe and correct operation of the equipment and to keep the warranty valid.

Even original spare parts may be installed only by authorized service personnel.

In case the equipment was opened by unauthorized personnel, no warranty regarding personal safety, measurement accuracy, conformity with applicable safety measures or any consequential damage is granted by the manufacturer.

Any warranty claims will be forfeited when the warranty seal has been damaged or removed.

Meaning of Symbols on the Instrument

-  Warning concerning a point of danger (Attention, observe documentation!)
-  Protection class II device
-  Charging socket for extra-low direct voltage (charger Z502R)
Attention!
Only rechargeable batteries may be inserted when the charger is connected.
-  This device may not be disposed of with the trash. Further information regarding the WEEE mark can be accessed on the Internet at www.gossenmetrawatt.com by entering the search term "WEEE".
-  EC mark of conformity



Any warranty claims will be forfeited when the warranty seal has been damaged or removed.

Calibration Seal (blue seal):

XY123	Consecutive number
D-K	Deutsche Akkreditierungsstelle GmbH – calibration lab
15080-01-01	Registration number
2012-06	Date of calibration (year – month)

See also “Recalibration” on page 96.

Data Backup

We advise you to regularly transmit your stored data to a PC in order to prevent potential loss of data in the test instrument.

We assume no responsibility for any data loss.

We recommend the following PC software programs for data processing and management:

- ETC
- E-Befund Manager (Austria)
- Protokollmanager
- PS3 (documentation, management, report generation and monitoring of deadlines)
- PC.doc-WORD/EXCEL (report and list generation)
- PC.doc-ACCESS (test data management)

4 Initial Start-Up

4.1 Preparation for use

Before putting the test instrument into service and using it for the first time, the lamination sheets must be removed from the two sensor surfaces (finger contacts) of the test plug in order to ensure that contact voltage is reliably detected.

4.2 Installing or Replacing the Battery Pack



Attention!

Before opening the battery compartment, disconnect the instrument from the measuring circuit (mains) at all poles!



Note

See also section 20.2 on page 87 concerning charging the Kompkt Akku Pack Master (Z502H) and the battery charger Z502R.

Use Kompakt Akku Pack Master (Z502H), if possible, which is either included in the standard equipment or available as an accessory, with heat-sealed battery cells. Do not use any battery holders which can be filled with individual batteries. This ensures that always a complete set of batteries is replaced and all rechargeable batteries are inserted with correct polarity in order to prevent leakage from the batteries.

Only use commercially available battery packs if you charge them externally. The quality of these sets cannot be verified and this may, in unfavourable cases, lead to heating and deformation (during the charging in the device).

Dispose the battery packs or the individual rechargeable batteries in an environmentally sound fashion when their service life has nearly expired (approx. 80% charging capacity).

- ⇨ Loosen the slotted screw for the battery compartment lid on the back and remove the lid.
- ⇨ Remove the discharged battery pack or the battery holder.



Attention!

When Using a Battery Holder:

It is imperative that you pay attention to the correct polarity when inserting the rechargeable batteries. If a battery has been inserted with incorrect polarity, it is not detected by the instrument and may lead to battery leakage.

Individual rechargeable batteries may only be charged externally.

- ⇨ Slide the new battery pack/filled battery holder into the battery compartment. The holder can only be inserted to its proper position.
- ⇨ Replace the lid and re-tighten the screw.

4.3 Switching the Instrument On/Off

The test instrument is switched on by pressing the **ON/START** key. The menu which corresponds to the momentary selector switch position is displayed.

The instrument can be switched off manually by simultaneously pressing the **MEM** and **HELP** keys.

After the period of time selected in the **SETUP** menus has elapsed, the instrument is switched off automatically (see “Device Settings”, section 4.6).

4.4 Battery Test

If battery voltage has fallen below the permissible lower limit, the pictograph shown at the right



appears. “Low Batt!!!” is also displayed along with a battery symbol. The instrument does not function if the batteries have been depleted excessively, and no display appears.

4.5 Charging the Battery Pack in the Tester



Attention!

Use only the charger Z502R to charge the **Kompakt Akku-Pack Master (Z502H)** which has already been inserted into the test instrument.

Make sure that the following conditions have been fulfilled before connecting the charger to the charging socket:

- Kompakt Akku-Pack Master (Z502H) has been installed, no commercially available battery packs, no individual rechargeable batteries, no standard batteries
- The test instrument has been disconnected from the measuring circuit at all poles
- The instrument must remain off during charging.

Refer to section 20.2.1 with regard to charging the battery pack which has been inserted into the tester.

If the batteries or the battery pack have not been used or recharged for a lengthy period of time (> 1 month), thus resulting in excessive depletion:

Observe the charging sequence (indicated by LEDs at the charger) and initiate a second charging sequence if necessary (disconnect the charger from the mains and from the test instrument to this end, and then reconnect it).

Please note that the system clock stops in this case and must be set to the correct time after the instrument has been restarted.

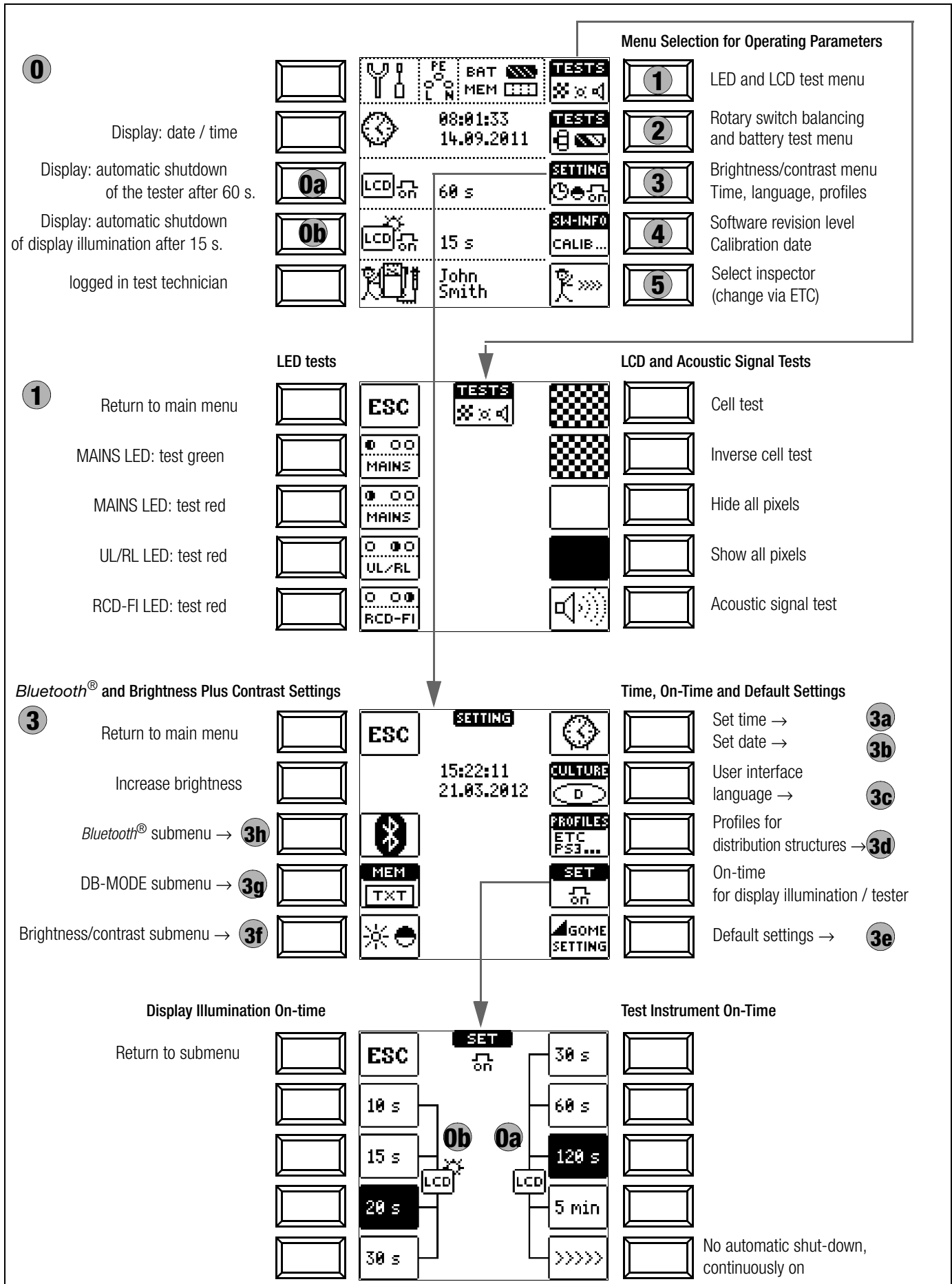

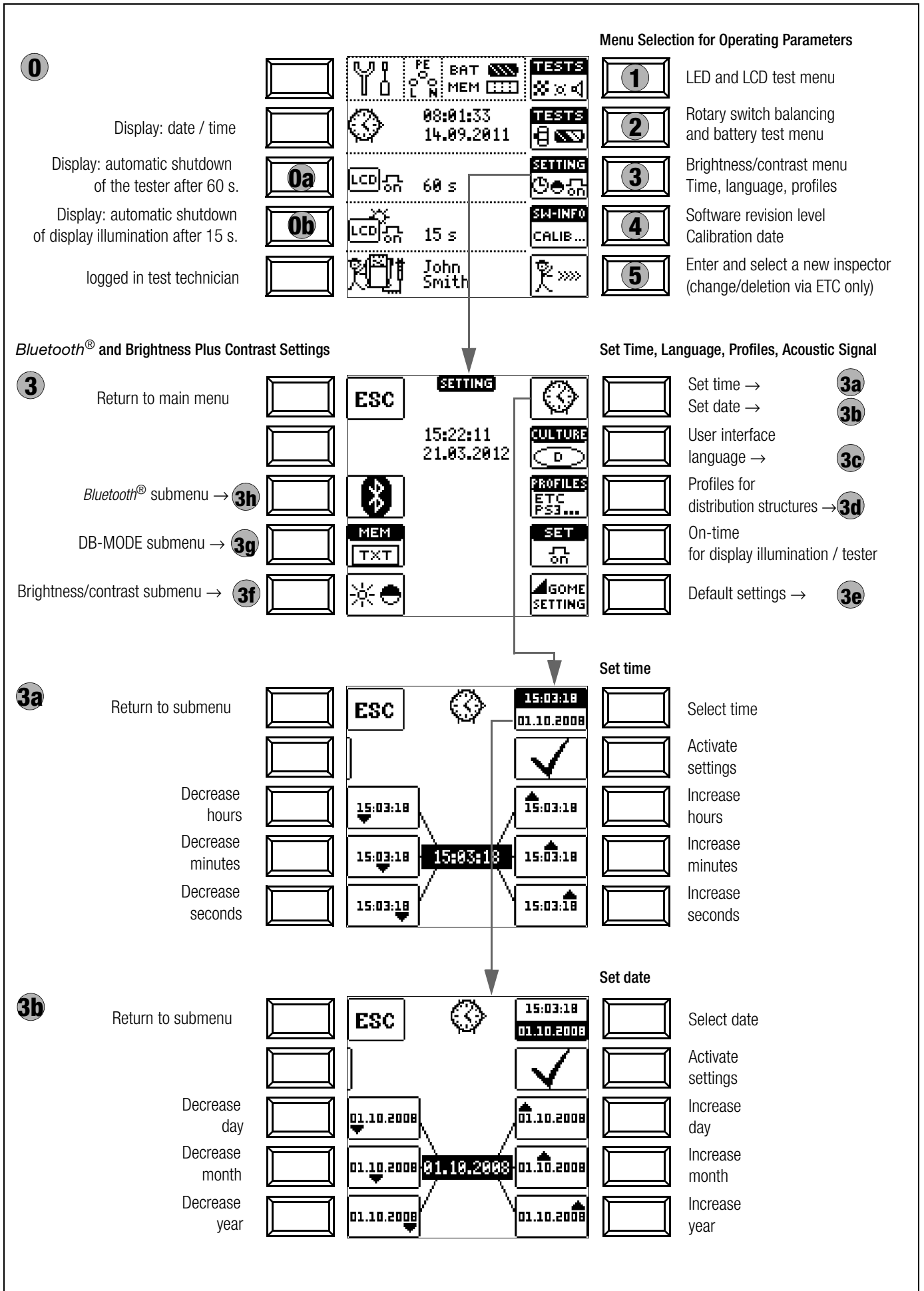

Significance of Individual Parameters

0a Test Instrument On-Time

The period of time after which the test instrument is automatically shut off can be selected here. This selection has a considerable influence on the service life and the charging status of the batteries.

0b On-Time for LCD Illumination

The period of time after which LCD illumination is automatically shut off can be selected here. This selection has a considerable influence on the service life and the charging status of the batteries.

Submenu: Rotary Switch Balancing

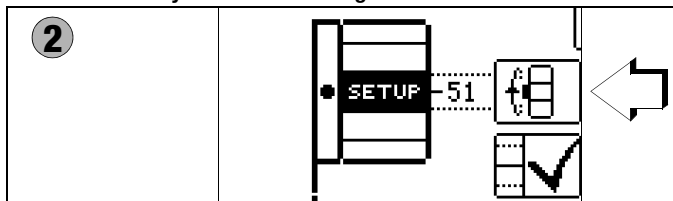

Proceed as follows in order to precisely adjust the rotary switch:

- 1 Press the TESTS Rotary Switch / Battery Test softkey in order to access the rotary switch balancing menu.
- 2 Then press the softkey with the rotary switch symbol.
- 3 Turn the rotary switch clockwise to the next respective measuring function (IDN first after SETUP).
- 4 Press the softkey which is assigned to the rotary switch at the LCD. After pressing this softkey, the display is switched to the next measuring function. Labeling in the LCD image must correspond to the actual position of the rotary switch.

The level bar in the LCD image of the rotary switch should be located in the middle of the black field, and is supplemented at the right-hand side with a number within a range of -1 to 101. This value should be between 45 and 55. In the case of -1 or 101, the position of rotary knob does not coincide with the measuring function selected at the LCD.

- 5 If the displayed value is not within this range, readjust the position by pressing the readjust softkey. A brief acoustic signal acknowledges readjustment.

Note

If labeling in the LCD image of the rotary switch does not correspond with its actual position, a continuous acoustic signal is generated as a warning when the readjust softkey is pressed.

- 6 Return to point 2 and continue. Repeat this procedure until all rotary switch functions have been tested, and if necessary readjusted.

⇒ Press **ESC** in order to return to the main menu.

Submenu: Battery Level Query

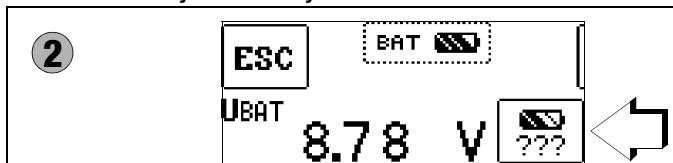

If battery voltage has dropped to 8.0 V or less, the UL/RL LED lights up red and an acoustic signal is generated as well.

Note

Measuring Sequence

If battery voltage drops to below 8.0 V during the course of a measuring sequence, this is indicated by means of a pop-up window only. Measured values are invalid. The measurement results cannot be saved to memory.



⇒ Press **ESC** in order to return to the main menu.



Attention!

Data and sequences are lost when the language, the profile or DB mode is changed, or if the instrument is reset to default values!

Back up your structures, measurement data and sequences to a PC before pressing the respective key. The prompt window at the right asks you to confirm deletion.



3c User Interface Language (CULTURE)

- ⇒ Select the desired country setup with the appropriate country code. **Attention: all existing structures, data and sequences are deleted, see note above!**

3d Profiles for Distributor Structures (PROFILES)

The profiles are laid out in a tree structure. The tree structure for the utilized PC evaluation program may differ from that of the PROFITEST MASTER. For this reason, the PROFITEST MASTER provides the user with the opportunity of adapting this structure.

Selecting a suitable profile determines which object combinations are made possible. For example, this makes it possible to create a distributor which is subordinate to another, or to save a measurement to a given building.

- ⇒ Select the PC evaluation program you intend to use. **Attention: all existing structures, data and sequences are deleted, see note above!**

If you have not selected a suitable PC evaluation program and, for example, if measured value storage to the selected location within the structure is not possible, the pop-up window shown at the right appears.

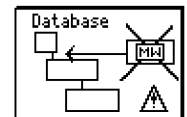

3e Default Settings (GOME SETTING)

The test instrument is returned to its original default settings when this key is activated.

Attention: all existing structures, data and sequences are deleted, see note above!

3f Adjusting Brightness and Contrast

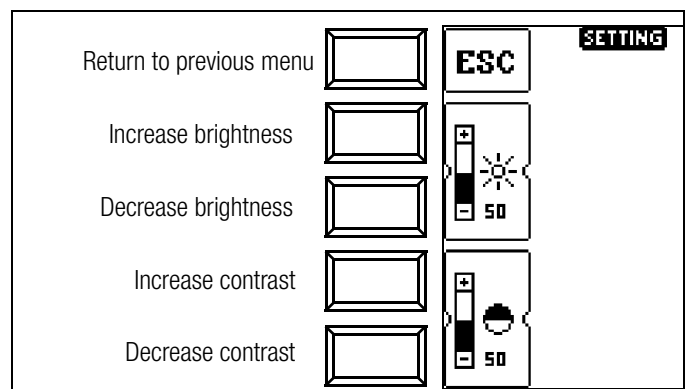

3g DB MODE – Presenting the Database in Text Mode or ID Mode

The DB MODE functions are available as of firmware version 01.05.00 of the test instrument and as of ETC version 01.31.00.

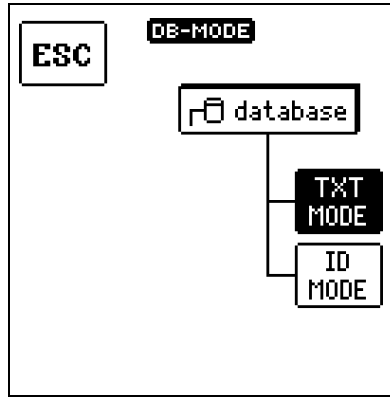

Creating Structures in TXT MODE

By default, the database in the test instrument is set to text mode, „TXT“ is indicated in the header. You can create structural elements in the test instrument and add designations in plain text, e. g. Customer XY, Distributor XY and Electrical Circuit XY.

Creating Structures in ID MODE

Alternatively, you can work in the ID mode. „ID“ is indicated in the header. You can create structural elements in the test instrument which can be labelled with ID numbers at your discretion.



Note

When data are transferred from the test instrument to the PC or ETC, ETC always retains the presentation (TXT or ID mode) selected in the test instrument. When data are transferred from the PC or ETC to the test instrument, the test instrument always retains the presentation selected in ETC. So, the respective receiver of the data always adopts the presentation of the sender.



Note

In the test instrument, structures can either be created in text mode or in ID mode. In the ETC software, however, designations and ID numbers are always allocated.

If no texts or ID numbers have been allocated when creating the structures in the test instrument, ETC generates the missing entries automatically. They can be subsequently edited in the ETC software and transferred back to the test instrument if required.

3h Switching Bluetooth® On/Off (MTECH+/MXTRA/SECULIFE IP only)

Figure 1

Figure 2

Figure 3

Figure 4

When Bluetooth® is active (= ON), the Bluetooth® icon appears in the header instead of BAT, and an interface icon appears instead of MEM.

A closed interface icon indicates an active Bluetooth connection with data transmission.

If your PC is equipped with a Bluetooth® interface, wireless communication is possible between the MTECH+, MXTRA or SECULIFE IP and ETC user software for the transfer of data and test structures. One-time only authentication of the respective PC with the test instrument is a prerequisite for wireless data exchange. The function selector switch must be in the SETUP position to this end. The correct Bluetooth® COM port must also be selected in ETC before each data transmission sequence.



Note

Activate the Bluetooth® interface at the test instrument during data transmission only. Interface power consumption reduces battery service life when activated continuously.

If several test instruments are within range during authentication, the respective name should be changed in order to rule out the possibility of a mix-up. Blanks may not be used. The default pin code, namely “0000”, can be changed, but this is unnecessary as a rule. As shown in figure 3, the MAC address of the test instrument is displayed in the footer as **hardware information**.

Render your test instrument visible prior to authentication, and subsequently invisible for security reasons.

Steps Required for Authentication

Make sure that the test instrument is within range of the PC (roughly 5 to 8 meters). Activate *Bluetooth*® at the test instrument (see figure 1) and at your PC.

The function selector switch must be in the SETUP position to this end.

Make sure that the test instrument (see figure 3) and your PC are visible for other *Bluetooth*® devices:

In the case of the test instrument, the word “**visible**” must be displayed underneath the eye symbol.

Use your *Bluetooth*® PC driver software to add a new *Bluetooth*® device. In most cases, this is accomplished with the help of the “Add new connection” or “Add *Bluetooth*® device” button.

The following steps may vary, depending on which *Bluetooth*® PC driver software is used. Basically, a PIN code must be entered at the PC. The default setting for the PIN code is “0000”, and is displayed in the main *Bluetooth*® menu (see figure 1) at the test instrument. Subsequently, or previously, an authentication message must be acknowledged at the test instrument (see figure 4).

If authentication has been successful, a corresponding message appears at the test instrument. Furthermore, the authenticated PC is displayed in the “Trusted Devices” menu at the test instrument (see figure 2).

The **MTECH+**, **MXTRA** or the **SECULIFE IP** should now also be listed as a device in your *Bluetooth*® PC driver software. Further information is also provided here regarding the utilized COM port. With the help of your *Bluetooth*® PC driver software, you’ll need to find out which COM port is used for the *Bluetooth*® connection. This port is frequently displayed after authentication, but if this is not the case, this information provided by your *Bluetooth*® PC driver software.

ETC includes a function for automatically ascertaining the utilized COM port after successful authentication has been completed (see screenshot below).

If the test instrument is within range of your PC (5 to 8 meters), wireless data exchange can now be initiated with the help of ETC by clicking *Bluetooth*® in the “Extras” menu. The number of the correct COM port (e.g. COM40) must be entered to ETC when data exchange is started (see screenshot below).

Alternatively, the COM port number can be selected automatically by clicking the “Find Bluetooth Device” item in the menu.

Firmware Revision and Calibration Information (example)

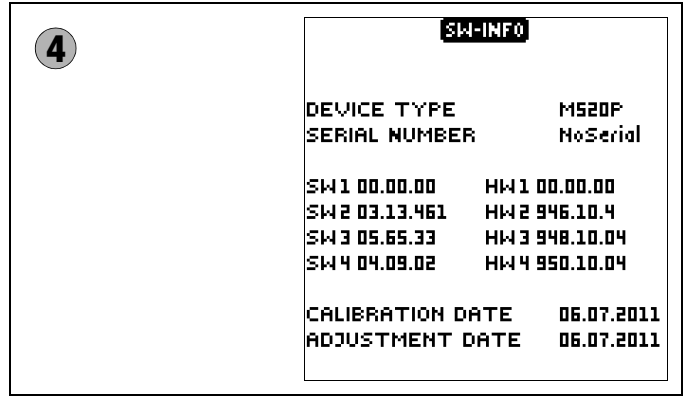

➤ Press any key in order to return to the main menu.

Firmware Update with the MASTER Updater

The layout used for the entire range of the test instruments makes it possible to adapt instrument software to the latest standards and regulations. Beyond this, suggestions from customers result in continuous improvement of the test instrument software, as well as new functions.

In order to assure that you can take advantage of all of these benefits without delay, the MASTER Updater allows you to quickly and completely update your test instrument software on-site.

The user interface can be set to either English, German or Italian.



Note

As a registered user, you’re entitled to download the MASTER Updater and the current firmware version free of charge from the myGMC page.

5 Entering and Selecting a New Inspector

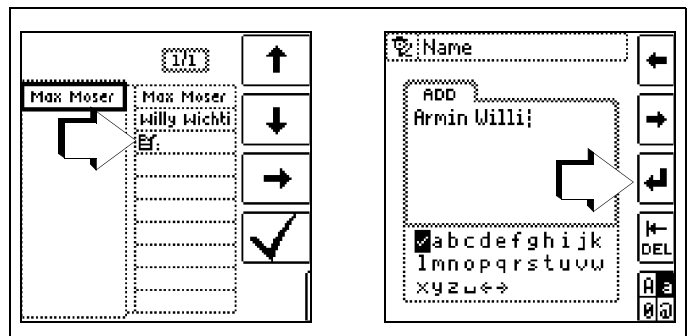

See also section 5.7 page 15 regarding the entry of a text.

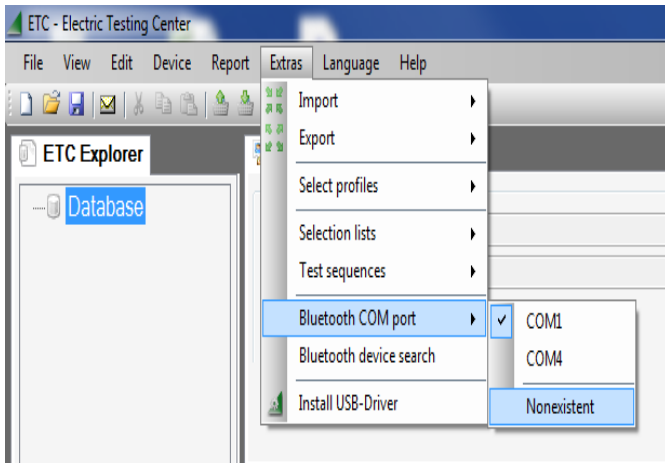

5 General Notes

5.1 Connecting the Instrument

For systems with earthing contact sockets, connect the instrument to the mains with the test plug to which the appropriate, country-specific plug insert is attached. Voltage between phase conductor L and the PE protective conductor may not exceed 253 V!

Poling at the socket need not be taken into consideration. The instrument detects the positions of phase conductor L and neutral conductor N and automatically reverses polarity if necessary. This does not apply to the following measurements:

- Voltage measurement in switch position U
- Insulation resistance measurement
- Low-value resistance measurement

The positions of phase conductor L and neutral conductor N are identified on the plug insert.

If measurement is to be performed at three-phase outlets, at distribution cabinets or at permanent connections, the measuring adapter must be attached to the test plug (see also table 16.1). Connection is established with the test probes: one at PE or N and the other at L.

The 2-pole measuring adapter must be expanded to 3 poles with the included measurement cable for the performance of phase sequence testing.

Contact voltage (during RCCB testing) and earthing resistance can be, and earth-electrode potential, standing surface insulation resistance and probe voltage must be measured with a probe. The probe is connected to the probe connector socket with a 4 mm contact protected plug.

5.2 Automatic Settings, Monitoring and Shut-Off

The test instrument automatically selects all operating conditions which it is capable of determining itself. It tests line voltage and frequency. If these lie within their valid nominal ranges, they appear at the display panel. If they are not within nominal ranges, prevailing voltage (U) and frequency (f) are displayed instead of U_N and f_N .

Contact voltage which is induced by test current is monitored for each measuring sequence. If contact voltage exceeds the limit value of > 25 V or > 50 V, measurement is immediately interrupted. The U_L/R_L LED lights up red.

If **battery voltage** falls below the allowable limit value the instrument cannot be switched on, or it is immediately switched off.

The measurement is interrupted automatically, or the measuring sequence is blocked (except for voltage measuring ranges and phase sequence testing) in the event of:

- Impermissible line voltages (< 60 V, > 253 V / > 330 V / > 440 V or > 550 V) for measurements which require line voltage
- Interference voltage during insulation resistance or low resistance measurements
- Overheating at the instrument.

As a rule, excessive temperatures only occur after approximately 50 measurement sequences at intervals of 5 seconds, when the rotary selector switch is set to the Z_{L-PE} oder Z_{L-N} position.

If an attempt is made to start a measuring sequence, an appropriate message appears at the display panel.

The instrument only switches itself off automatically after completion of an automatic measuring sequence, and after the predetermined on-time has expired (see section 4.3). On-time is reset to its original value as defined in the setup menu, as soon as any key or the rotary selector switch is activated.

The instrument remains on for approximately 75 seconds in addition to the preset on-time for measurements with rising residual current in systems with selective RCCBs.

The instrument always shuts itself off automatically!

5.3 Measurement Value Display and Memory

The following appear at the display panel:

- Measurement values with abbreviations and units of measure
- Selected function
- Nominal voltage
- Nominal frequency
- Error messages

Measurement values for automatic measuring sequences are stored and displayed as digital values until the next measurement sequence is started, or until automatic shut-off occurs.

If the upper range limit is exceeded, the upper limit value is displayed and is preceded by the “>” symbol (greater than), which indicates measurement value overrun.



Note

The depiction of LEDs in these operating instructions may vary from the LEDs on the actual instrument due to product improvements.

5.4 Testing Earthing Contact Sockets for Correct Connection

The testing of earthing contact sockets for correct connection prior to protective measures testing is simplified by means of the instrument's error detection system.

The instrument indicates improper connection as follows:

- **Impermissible line voltage (< 60 V or > 253 V):**
The MAINS/NETZ LED blinks red and the measuring sequence is disabled.
- **Protective conductor not connected or potential to earth ≥ 50 V at ≥ 50 Hz** (switch position U – single-phase measurement):
If the contact surfaces are touched (**finger contact***) while PE is being contacted (via the country-specific plug insert, e.g. SCHUKO, as well as via the PE test probe at the 2-pole adapter) PE appears (only after a test sequence has been started). The U_L/R_L and RCD/FI LEDs light up red as well.
* for reliably detecting the contact voltages, both sensor surfaces at the test plug must be touched directly with the finger/palm without any skin protection applied, see also section 4.1.
- **Neutral conductor N not connected** (during mains dependent measurements):
The MAINS/NETZ LED blinks green.
- **One of the two protective contacts is not connected:**
This is checked automatically during testing for contact current $U_{\Delta N}$. Poor contact resistance at one of the contacts leads to one of the following displays, depending upon poling of the plug:

- **Display at the connection pictograph:**

PE interrupted (x), or underlying protective conductor bar interrupted with reference to keys at the test plug

Cause: voltage measuring path interrupted
Consequence: measurement is disabled

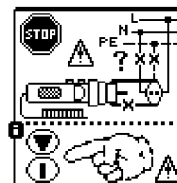

- **Display at the connection pictograph:**

Overlying protective conductor bar interrupted with reference to keys at the test plug

Cause: current measuring path interrupted
Consequence: no measured value display

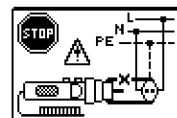

Note

See also “LED Indications, Mains Connections and Potential Differences” beginning on page 73.



Attention!

Reversal of N and PE in a system without RCCBs cannot be detected and is not indicated by the instrument. In a system including an RCCB, the RCCB is tripped during “contact voltage measurement without RCCB tripping” (automatic Z_{L-N} measurement), insofar as N and PE are reversed.

5.5 Help Function

The following information can be displayed for each switch position and basic function **after it has been selected with the rotary selector switch**:

- Wiring diagram
- Measuring range
- Nominal range of use and measuring uncertainty
- Nominal value



• Measurement of $U_{I\Delta N}$ and R_E with $I_{\Delta N}$, without tripping of RCD.
 • $U_{I\Delta N}$ - and R_E -Measure: Press **START**
 • Subsequently, trip RCD: Press **I Δ N**

- Press the **HELP** key in order to query online help:
- If several pages of help are available for the respective measuring function, the **HELP** key must be pressed repeatedly.
- Press the **ESC** key in order to exit online help.

5.6 Setting Parameters or Limit Values using RCD Measurement as an Example

- 1 Access the submenu for setting the desired parameter.
- 2 Select a parameter using the \uparrow or \downarrow scroll key.
- 3 Switch to the setting menu for the selected parameter with the \rightarrow scroll key.
- 4 Select a setting value using the \uparrow or \downarrow scroll key.
- 5 Acknowledge the setting value with the \downarrow key. This value is transferred to the setting menu.
- 6 The setting value is not permanently accepted for the respective measurement until \checkmark is pressed, after which the display is returned to the main menu. You can return to the main menu by pressing **ESC** instead of \checkmark , without accepting the newly selected value.

Parameter Lock (plausibility check)

Individually selected parameter settings are checked for plausibility before transfer to the measurement window.

If you select a parameter setting which doesn't make sense in combination with other parameter settings which have already been entered, it's not accepted. The previously selected parameter setting remains unchanged.

Remedy: Select another parameter setting.

5.7 Freely Selectable Parameter Settings or Limit Values

In addition to fixed values, other values can be freely selected within predefined limits for certain parameters, if the symbol for the EDIT menu (3) appears at the end of the list of setting values.

Freely Selecting a Limit Value or Nominal Voltage

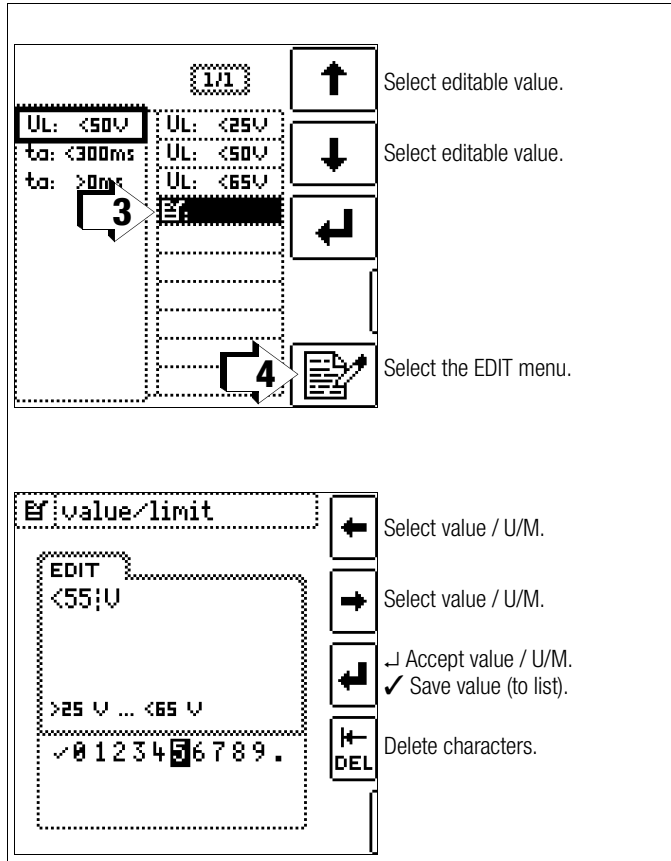

- 1 Open the submenu for setting the desired parameter (no figure, see section 5.6).
- 2 Select parameter (U_L) using the \uparrow or \downarrow scroll key (no figure, see section 5.6).
- 3 Select a setting value with the help of the EDIT icon and the \uparrow or \downarrow scroll key.
- 4 Select the edit menu: Press the key with the EDIT icon.
- 5 Select the desired value or unit of measure with the LEFT or RIGHT scroll key. The value or unit of measure is accepted by pressing the \downarrow key. The entire value is acknowledged by selecting \checkmark and then pressing the \downarrow key. The new limit value or nominal value is added to the list.

Note

Observe predefined limits for the new setting value. New, freely selected limit values or nominal values included in the parameters list can be deleted/edited at the PC with the help of ETC software. When the upper limit value is exceeded, this value is accepted (in the example: 65 V), when the limit value is fallen short of, the predefined lower limit value (25 V) is accepted.

5.8 2-Pole Measurement with Fast or Semiautomatic Polarity Reversal

Fast, semiautomatic polarity reversal is possible for the following measurements:

- Voltage U
- Loop impedance Z_{L-P-E}
- Internal line resistance measurement Z_{L-N}
- Insulation resistance, R_{INS}

Fast Polarity Reversal at the Test Plug

The polarity parameter is set to **AUTO**.

Fast and convenient switching amongst all polarity variants, or switching to the parameter settings submenu, is possible by pressing the $I_{\Delta N}$ key at the instrument or the test plug.

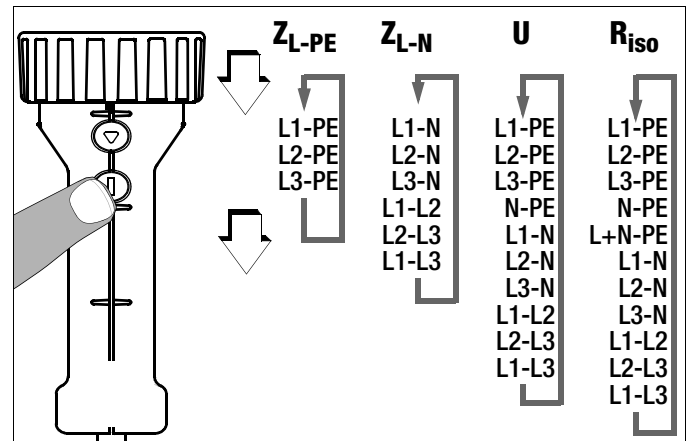
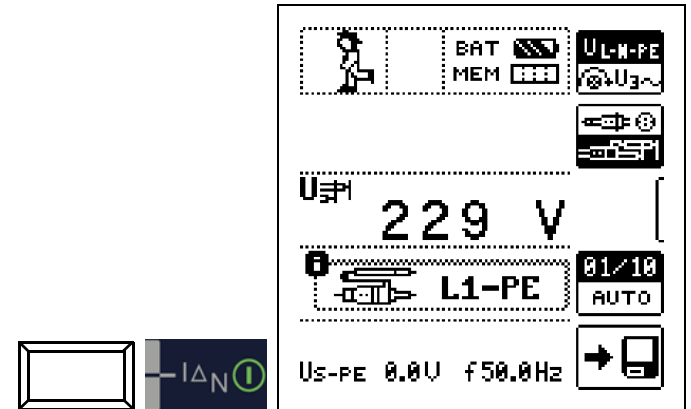

Semiautomatic Polarity Reversal in Memory Mode

The polarity parameter is set to **AUTO**.

If testing is to be conducted with all polarity variants, automatic polarity changing takes place after each measurement when the "Save" button is pressed.

Polarity variants can be skipped by pressing the $I_{\Delta N}$ key at the instrument or the test plug.

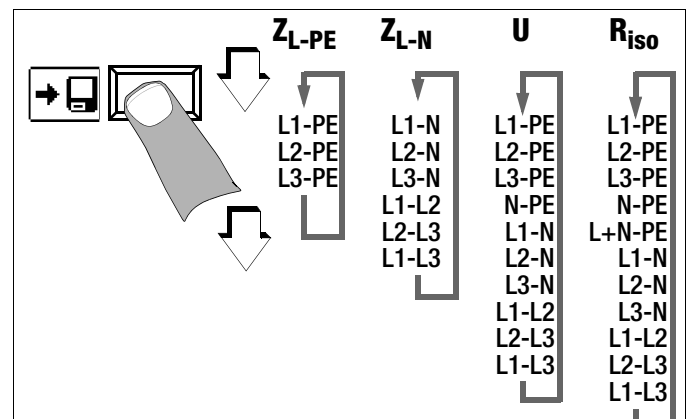

6 Measuring Voltage and Frequency

Select Measuring Function

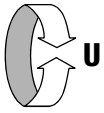

Switch Between Single and 3-Phase Measurement



Press the softkey shown at the left in order to switch back and forth between single and 3-phase measurement. The selected phase measurement is displayed inversely (white on black).

6.1 Single-Phase Measurement

Connection

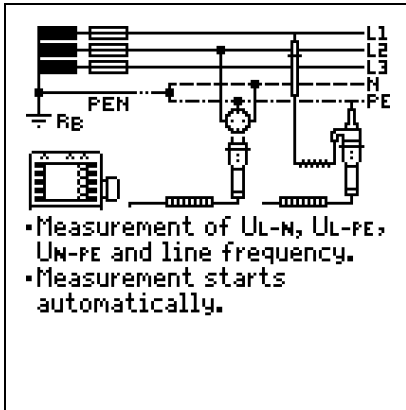

A probe must be used in order to measure probe voltage U_{S-PE} .

6.1.1 Voltage Between L and N (U_{L-N}), L and PE (U_{L-PE}) and N and PE (U_{N-PE}) with Country-Specific Plug Insert, e.g. SCHUKO



Press the softkey shown at the left in order to switch back and forth between the country-specific plug insert, e.g. SCHUKO, and the 2-pole adapter. The selected connection type is displayed inversely (white on black).

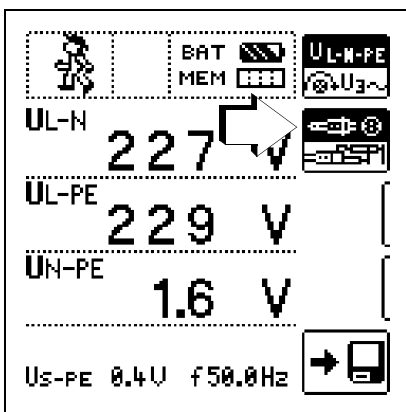

6.1.2 Voltage between L – PE, N – PE and L – L with 2-Pole Adapter Connection



Press the softkey shown at the left in order to switch back and forth between the country-specific plug insert, e.g. SCHUKO, and the 2-pole adapter. The selected connection type is displayed inversely (white on black).

Refer to section 5.8 regarding 2-pole measurement with fast or semiautomatic polarity reversal.

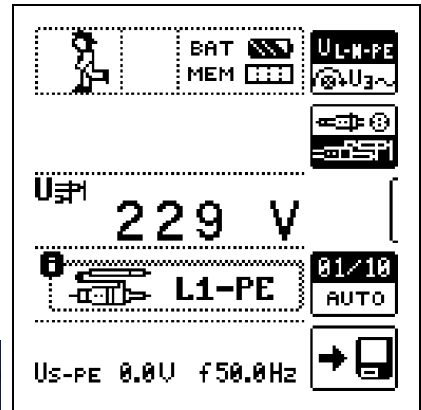
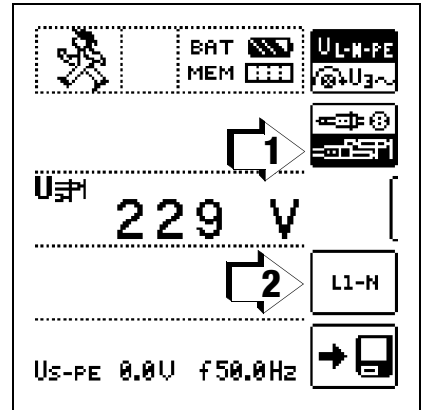

6.2 3-Phase Measurement (line-to-line voltage) and Phase Sequence

Connection

The measuring adapter (2-pole) is required in order to connect the instrument, and can be expanded to a 3-pole measuring adapter with the included measurement cable.

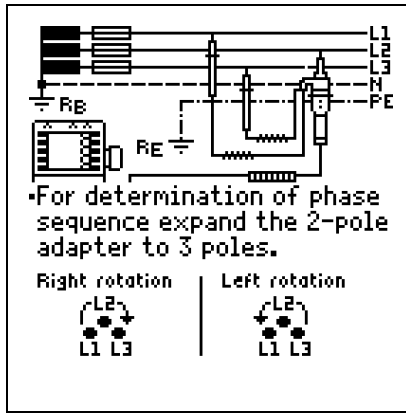

➤ Press softkey U3~.

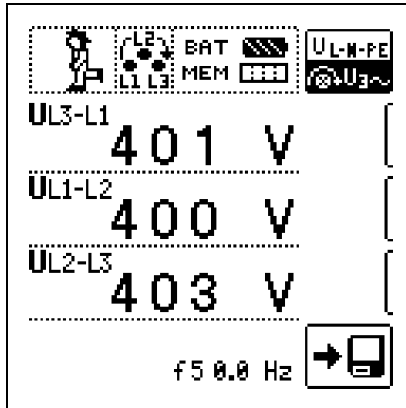

A clockwise phase sequence is required at all 3-phase electrical outlets.

- Measurement instrument connection is usually problematic with CEE outlets due to contact problems. Measurements can be executed quickly and reliably without contact problems with the help of the Z500A variable plug adapter set available from GMC.
- Connection for 3-wire measurement, plug L1-L2-L3 in clockwise direction as of PE socket

Direction of rotation is indicated by means of the following displays:



Note

See section 18 regarding all indications for the mains connection test.

Voltage Polarity

If the installation of single-pole switches to the neutral conductor is prohibited by the standards, voltage polarity must be tested in order to assure that all existing single-pole switches are installed to the phase conductors.

7 Testing RCDs

The testing of residual current devices (RCDs) includes:

- Visual inspection
- Testing
- Measurement

Use the test instrument for testing and measurement.

Measuring Method

The following must be substantiated by generating a fault current downstream from the RCD:

- That the RCD is tripped no later than upon reaching its nominal fault current value
- That the continuously allowable contact voltage value U_L agreed upon for the respective system is not exceeded

This is achieved by means of:

- Contact voltage measurement, 10 measurements with full-waves and extrapolation of $I_{\Delta N}$

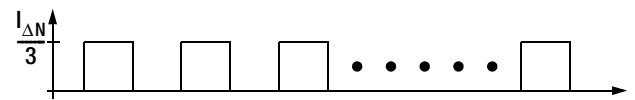

- Substantiation of tripping within 400 ms or 200 ms with $I_{\Delta N}$

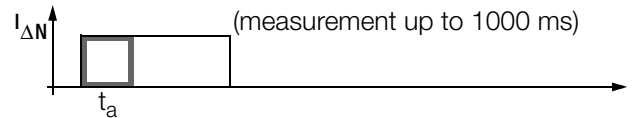

- Substantiation of tripping with current rising residual current: This value must be between 50% and 100% of $I_{\Delta N}$ (usually about 70%).

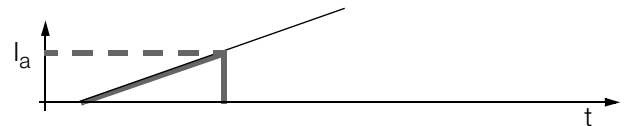

- No premature tripping with the test instrument, because testing is begun with 30% residual current (if no bias current occurs within the system).

RCD/FI Table	Type of Differential Current	Correct RCD/RCCB Function			
		Type AC	Type A, F	Type B*/B+*	Type EV*
Alternating current	Suddenly occurring 	✓	✓	✓	✓
	Slowly rising 				
Pulsating direct current	Suddenly occurring 		✓	✓	✓
	Slowly rising 				
Direct current				✓	✓
Direct current up to 6 mA					✓

* PROFITEST MTECH+, PROFITEST MXTRA & SECULIFE IP

Test Standard

The following must be substantiated per DIN VDE 0100 part 600: 2008:

- Contact voltage occurring at nominal residual current may not exceed the maximum allowable value for the system.
- Tripping of the RCCB must occur within 400 ms (1000 ms for selective RCDs) at nominal residual current.

Important Notes

- The **PROFITEST MASTER** allows for simple measurements at all types of RCDs. Select RCD, SRCD, PRCD etc.
- Measurement must be executed at one point only per RCD (RCCB) within the connected electrical circuits. Low-resistance continuity must be substantiated for the protective conductor at all other connections within the electrical circuit (R_{LO} or U_B).
- The measuring instruments often display a contact voltage of 0.1 V in TN systems due to low protective conductor resistance.
- Be aware of any bias currents within the system. These may cause tripping of the RCDs during measurement of contact voltage U_B , or may result in erroneous displays for measurements with rising current:
Display = I_F - $I_{bias_current}$
- Selective RCDs identified with an **S** can be used as the sole means of protection for automatic shutdown if they adhere to the same shutdown conditions as non-selective RCDs (i.e. $t_a < 400$ ms). This can be substantiated by measuring shutdown time.
- Type B RCDs may not be connected in series with type A RCDs.



Note

Bias Magnetization

Only AC measurements can be performed with the 2-pole adapter. Suppression of RCD tripping by means of bias magnetization with direct current is only possible via a country-specific plug insert, e.g. SCHUKO, or the 3-pole adapter.

Measurement With or Without Probe

Measurements can be performed with or without a probe.

Measurements with probe require that the probe and reference earth are of like potential. This means that the probe must be positioned outside of the potential gradient area of the earth electrode (R_E) in the RCD safety circuit.

The distance between the earth electrode and the probe should be at least 20 m.

The probe is connected with a 4 mm contact protected plug.

In most cases this measurement is performed without probe.



Attention!

The probe is part of the measuring circuit and may carry a current of up to 3.5 mA in accordance with VDE 0413.

Testing for the absence of voltage at the probe can be performed with the U_{PROBE} function (see also section 6.1 on page 16).

7.1 Measuring Contact Voltage (with reference to nominal residual current) with $\frac{1}{3}$ Nominal Residual Current and Tripping Test with Nominal Residual Current

Select Measuring Function



Connection

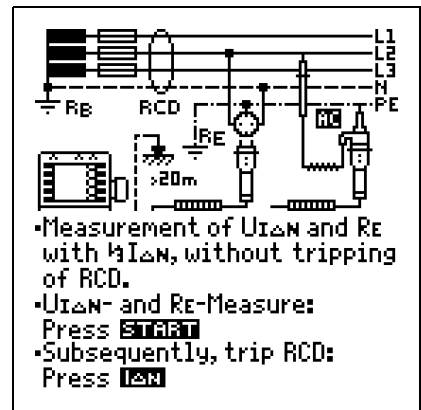

Set Parameters for $I_{\Delta N}$

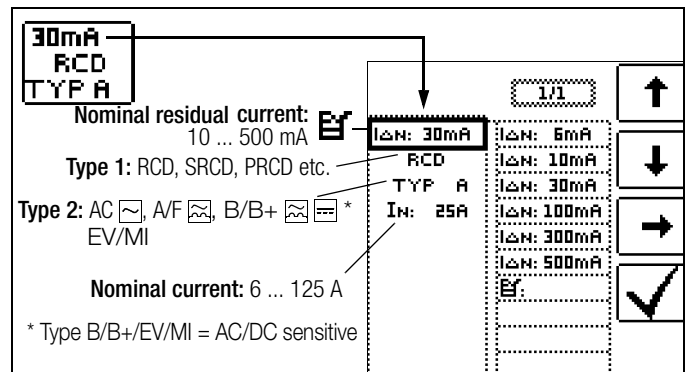
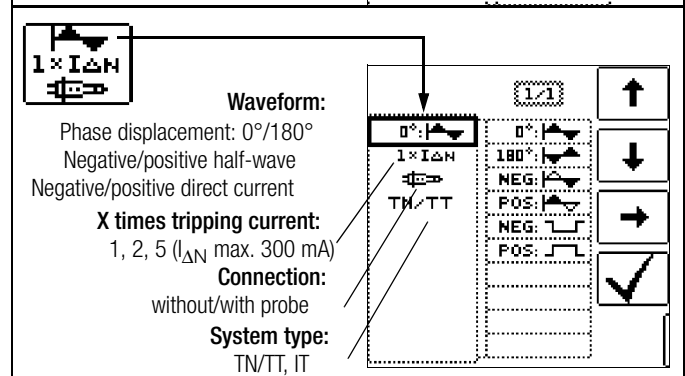
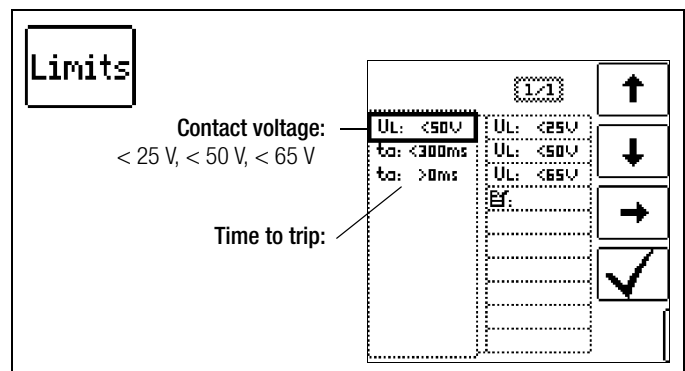
1) Measuring Contact Current Without Tripping the RCD

Measuring Method

The instrument uses a measuring current of only 1/3 nominal residual current for the determination of contact voltage $U_{I\Delta N}$ which occurs at nominal residual current. This prevents tripping of the RCCB.

This measuring method is especially advantageous, because contact voltage can be measured quickly and easily at any electrical outlet without tripping the RCCB.

The usual, complex measuring method involving testing for the proper functioning of the RCD at a given point, and subsequent substantiation that all other systems components requiring protection are reliably connected at low resistance values to the selected measuring point via the PE conductor, is made unnecessary.

N-PE Reversal Test

Additional testing is conducted in order to determine whether or not N and PE are reversed. The pop-up window shown at the right appears in the event of reversal.

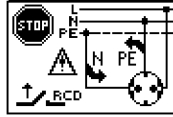

Attention!

Execute a data backup before starting measurement and switch off all consumers in order to prevent the loss of data in data processing systems.

Start Measurement

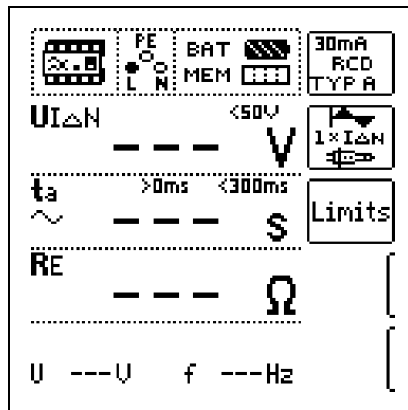

Amongst other values, contact voltage $U_{I\Delta N}$ and calculated earthing resistance R_E appear at the display panel.



Note

The measured earthing resistance value R_E is acquired with very little current. More accurate results can be obtained with the selector switch in the R_E position. The DC +  function can be selected here for systems with RCCBs.

Unintentional Tripping of the RCD due to Bias Current within the System

If bias currents should occur, they can be measured with the help of a current clamp transformer as described in section 13.1 on page 50. The RCCB may be tripped during the contact voltage test if extremely large bias currents are present within the system, or if a test current was selected which is too great for the RCCB. After contact voltage has been measured, testing can be performed to determine whether or not the RCCB is tripped within the selected time limits at nominal residual current.

Unintentional Tripping of the RCD due to Leakage Current in the Measuring Circuit

Measurement of contact voltage with 30% nominal residual current does not normally trip an RCCB. However, the trip limit may be exceeded as a result of leakage current in the measuring circuit, e.g. due to interconnected power consumers with EMC circuit, e.g. frequency converters and PCs.

2) Tripping Test after the Measurement of Contact Voltage

⇨ Press the $I_{\Delta N}$ key.

The tripping test need only be performed at one measuring point for each RCCB.

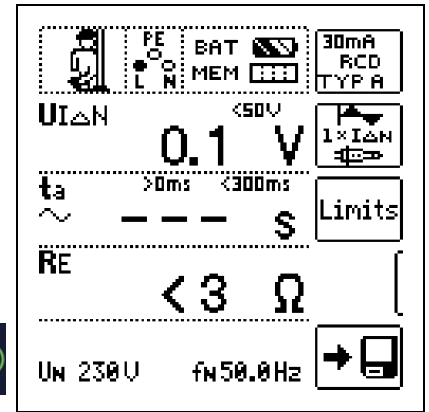

If the RCCB is tripped at nominal residual current,

the MAINS/NETZ LED blinks red (line voltage disconnected) and time to trip t_a and earthing resistance R_E appear at the display panel.

If the RCCB is not tripped at nominal residual current, the RCD/FI LED lights up red.

Contact Voltage Too High

If contact voltage $U_{I\Delta N}$, which has been measured with 1/3 nominal residual current $I_{\Delta N}$ and extrapolated to $I_{\Delta N}$, is > 50 V (> 25 V), the U_L/R_L LED lights up red.

If contact voltage $U_{I\Delta N}$ exceeds 50 V (25 V) during the measuring sequence, safety shut-down occurs.



Note

Safety Shut-down: At up to 70 V, a safety shut-down is tripped within 3 seconds in accordance with IEC 61010.

Contact voltages of up to 70 V are displayed. If contact voltage is greater than 70 V, $U_{I\Delta N} > 70$ V is displayed.

Limit Values for Allowable, Continuous Contact Voltage

The limit for allowable, continuous contact voltage is $U_L = 50$ V for alternating voltages (international agreement). Lower values have been established for special applications (e.g. medical applications: $U_L = 25$ V).



Attention!

If contact voltage is too high, or if the RCCB is not tripped, the system must be repaired (e.g. earthing resistance is too high, defective RCCB etc.)!

3-Phase Connections

For proper RCD testing at three-phase connections, the tripping test must be conducted for one of the three phase conductors (L1, L2 and L3).

Inductive Power Consumers

Voltage peaks may occur within the measuring circuit if inductive consumers are shut down during an RCCB trip test. If this is the case, the test instrument may display the following message: No measured value (---). If this message appears, switch all power consumers off before performing the trip test. In extreme cases, one of the fuses in the test instrument may blow, and/or the test instrument may be damaged.

7.2 Special Testing for Systems and RCCBs

7.2.1 Testing Systems and RCCBs with Rising Residual Current (AC) for Type AC, A/F, B/B+ and EV/MI RCDs

Measuring Method

The instrument generates a continuously rising residual current of $(0.3 \text{ to } 1.3) \cdot I_{\Delta N}$ within the system for the testing of RCDs.

The instrument stores the contact voltage and tripping current values which were measured at the moment tripping of the RCCB occurred, and displays them.

One of contact voltage limit values, $U_L = 25 \text{ V}$ or $U_L = 50 \text{ V}/65 \text{ V}$, can be selected for measurement with rising residual current.

Select Measuring Function

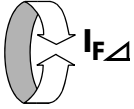

Connection

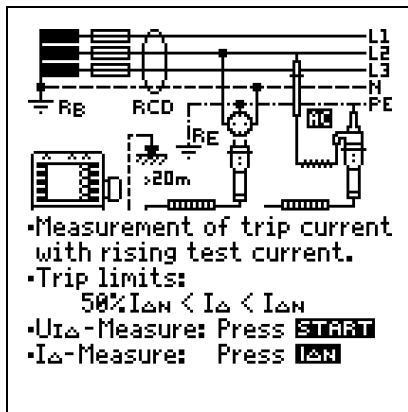

Set Parameters for $I_{\Delta N}$

Start Measurement

Measuring Sequence

After the measuring sequence has been started, the test current generated by the instrument is continuously increased starting at 0.3 times nominal residual current, until the RCCB is tripped. This can be observed by viewing gradual filling of the triangle at I_{Δ} .

If contact voltage reaches the selected limit value ($U_L = 65 \text{ V}$, 50 V or 25 V) before the RCCB is tripped, safety shut-down occurs. The U_L/R_L LED lights up red.



Note

Safety Shut-down: At up to 70 V, a safety shut-down is tripped within 3 seconds in accordance with IEC 61010.

If the RCCB is not tripped before the rising current reaches nominal residual current $I_{\Delta N}$, the RCD/FI LED lights up red.



Attention!

If bias current is present within the system during measurement, it is superimposed onto the residual current which is generated by the instrument and influences measured values for contact voltage and tripping current. See also section 7.1.

Evaluation

According to DIN VDE 0100, Part 600, rising residual current must, however, be used for measurements in the evaluation of RCDs, and contact voltage at nominal residual current $I_{\Delta N}$ must be calculated from the measured values.

The faster, more simple measuring method should thus be taken advantage of (see section 7.1).

7.2.2 Testing Systems and RCCBs with Rising Residual Current (AC) for Type B/B+ and EV/MI RCDs (nur MTECH+, MXTRA & SECULIFE IP)

In accordance with VDE 0413, part 6, it must be substantiated that, with smooth direct current, residual operating current is no more than twice the value of rated residual current $I_{\Delta N}$. A continuously rising direct current, beginning with 0.2 times rated residual current $I_{\Delta N}$, must be applied to this end. If current rise is linear, rising current may not exceed twice the value of $I_{\Delta N}$ within a period of 5 seconds.

Testing with smoothed direct current must be possible in both test current directions.

7.2.3 Testing RCCBS with $5 \cdot I_{\Delta N}$

The measurement of time to trip is performed here with 5 times nominal residual current.



Note

Measurements performed with 5 times nominal fault current are required for testing type S and G RCCBs in the manufacturing process. They are used for personal safety as well.

Measurement can be started with the positive half-wave at "0°" or with the negative half-wave at "180°".

Both measurements must nevertheless be performed. The longer of the two tripping times is decisive regarding the condition of the tested RCCB. Both values must be less than 40 ms.

Select Measuring Function

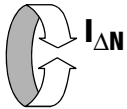

Set the Parameter – Start with Positive or Negative Half-Wave

Set the Parameter – 5 Times Nominal Current



Note

The following restrictions apply to the selection of tripping current multiples relative to nominal current:
500 mA: 1 x, 2 x $I_{\Delta N}$

Start Measurement

7.2.4 Testing of RCCBs which are Suited for Pulsating DC Residual Current

In this case, RCCBs can be tested with either positive or negative half-waves. The standard calls for tripping at 1.4 times nominal current.

Select Measuring Function

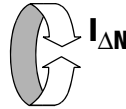

Set the Parameter – Positive or Negative Half-Wave

Set the Parameter – Test With and Without "Non-Tripping Test"

Non-Tripping Test

If, during the non-tripping test which lasts for 1 second, the RCD trips too early at $50\% I_{\Delta N}$, i.e. before the actual tripping test starts, the pop-up window shown at the right appears.

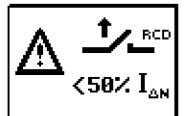

Note

The following restriction applies to the selection of tripping current multiples relative to nominal current: Double and five-fold nominal current is not possible in this case.



Note

According to DIN EN 50178 (VDE 160), only type B RCCBs (AC-DC sensitive) can be used for equipment with > 4 kVA, which is capable of generating smooth DC residual current (e.g. frequency converters). Tests with pulsating DC fault current only are not suitable for these RCCBs. Testing must also be conducted with smooth DC residual current in this case.



Note

Measurement is performed with positive and negative half-waves for testing RCCBs during manufacturing. If a circuit is charged with pulsating direct current, the function of the RCCB can be executed with this test in order to assure that the RCCB is not saturated by the pulsating direct current so that it no longer trips.

7.3 Testing for Special RCDs

7.3.1 System, Type RCD-S Selective RCCBs

Selective RCDs are used in systems which include two series connected RCCBs which are not tripped simultaneously in the event of a fault. These selective RCDs demonstrate delayed response characteristics and are identified with the **S** symbol.

Measuring Method

The same measuring method is used as for standard RCCBs (see sections 7.1 on page 18 and 7.2.1 on page 20).

If selective RCDs are used, earthing resistance may not exceed half of the value for standard RCCBs.

For this reason, the instrument displays twice the measured value for contact voltage.

Select Measuring Function

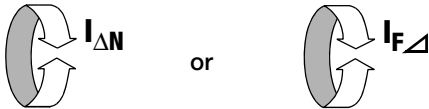

Set Parameter – Selective

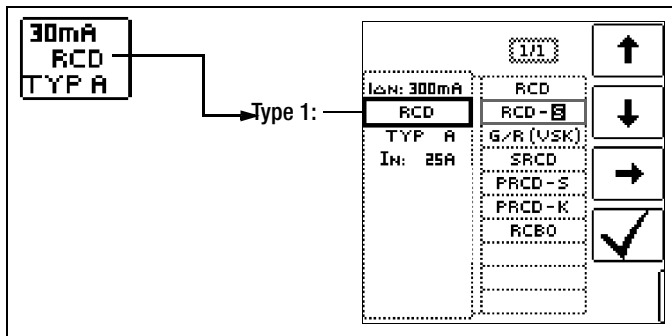

Start Measurement

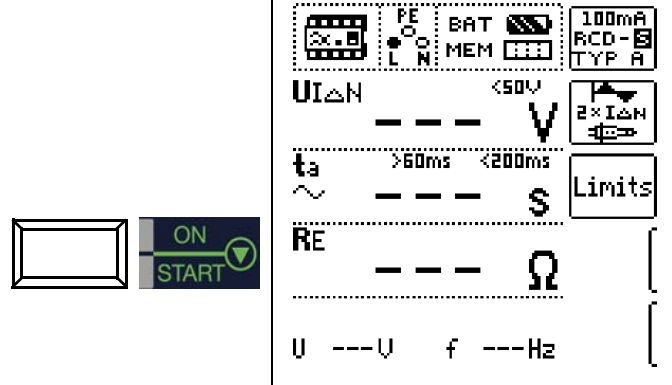

Tripping Test

- Press the $I_{\Delta N}$ key. The RCCB is tripped. Blinking bars appear at the display panel, after which time to trip t_A and earthing resistance R_E are displayed.

The tripping test need only be performed at one measuring point for each RCCB.

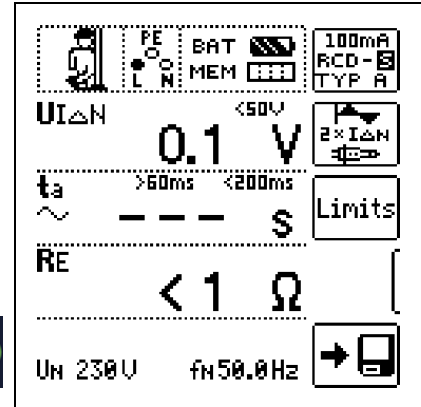

Note

Selective RCDs demonstrate delayed response characteristics. Tripping performance is briefly influenced (up to 30 s) due to pre-loading during measurement of contact voltage. In order to eliminate pre-charging caused by the measurement of contact voltage, a waiting period must be observed prior to the tripping test. After the measuring sequence has been started (tripping test), blinking bars are displayed for approximately 30 seconds. Tripping times of up to 1000 ms are allowable. The tripping test is executed immediately after once again pressing the $I_{\Delta N}$ key.

7.3.2 PRCDs with Non-Linear Type PRCD-K Elements

The PRCD-K is a portable RCD with electronic residual current evaluation laid out as an in-line device which switches all poles (L, N and PE). An undervoltage trigger and protective conductor monitoring are additionally integrated into the PRCD-K.

The PRCD-K is equipped with an undervoltage trigger, for which reason it has to be operated with line voltage, and measurements may only be performed in the on state (PRCD-K switches all poles).

Terminology (from DIN VDE 0661)

Portable protective devices are circuit breakers which can be connected between power consuming devices and permanently installed electrical outlets by means of standardized plug-and-socket devices.

A reusable, portable protective device is a protective device which is designed such that it can be connected to movable cables.

Please be aware that a non-linear element is usually integrated into PRCDs, which leads to immediate exceeding of the greatest allowable contact voltage during $U_{I\Delta}$ measurements ($U_{I\Delta}$ greater than 50 V).

PRCDs which do not include a non-linear element in the protective conductor must be tested in accordance with section 7.3.3 on page 23.

Objective (from DIN VDE 0661)

Portable residual current devices (PRCDs) serve to protect persons and property. They allow for the attainment of increased levels of protection as provided by protective measures utilized in electrical systems for the prevention of electrical shock as defined in DIN VDE 0100, part 410. They are to be designed such that they can be installed by means of a plug attached directly to the protective device, or by means of a plug with a short cable.

Measuring Method

The following can be measured, depending upon the measuring method:

- Time to trip t_A : tripping test with nominal residual current $I_{\Delta N}$ (The PRCD-K must be tripped at 50% nominal current.)
- Tripping current I_{Δ} : testing with rising residual current $I_{F\Delta}$

Select Measuring Function

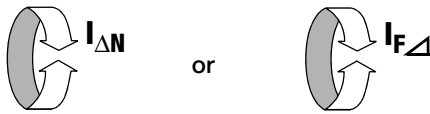

Connection

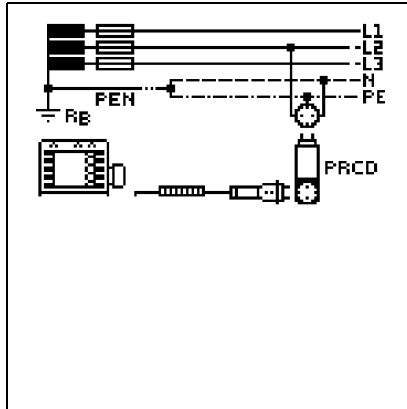

Set the Parameter – PRCD with Non-Linear Elements

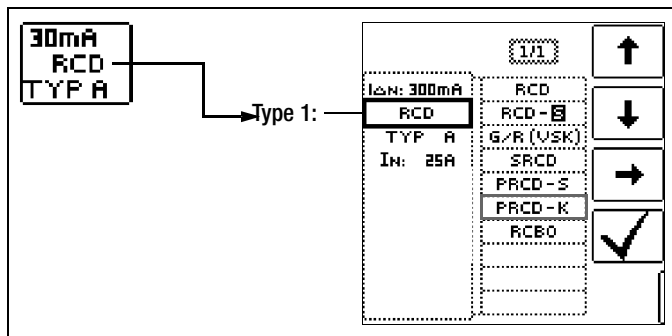

Start Measurement

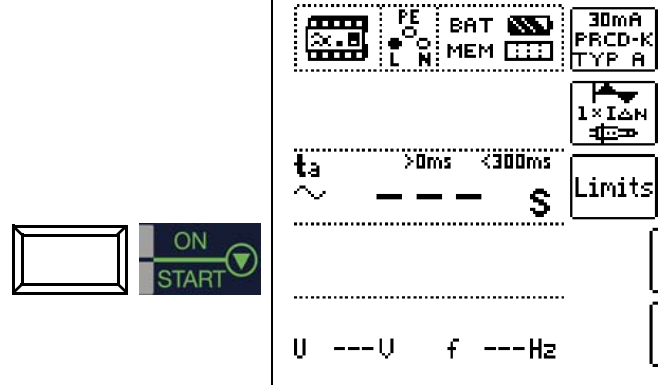

7.3.3 SRCD, PRCD-S (SCHUKOMAT, SIDOS or comparable)

RCCBs from the SCHUKOMAT SIDOS series, as well as others which are of identical electrical design, must be tested after selecting the corresponding parameter.

Monitoring of the PE conductor is performed for RCDs of this type. The PE conductor is monitored by the summation current transformer. If residual current flows from L to PE, tripping current is cut in half, i.e. the RCCB must be tripped at 50% nominal residual current $I_{\Delta N}$.

Whether or not PRCDs and selective RCDs are of like design can be tested by measuring contact voltage $U_{I\Delta N}$. If a contact voltage $U_{I\Delta N}$ of greater than 70 V is measured at the PRCD of an otherwise error-free system, the PRCD more than likely contains a non-linear element.

PRCD-S

The PRCD-S (portable residual current device – safety) is a special, portable, protective device with protective conductor detection or protective conductor monitoring. The device serves to protect persons from electrical accidents in the low-voltage range (130 to 1000 V). The PRCD-S must be suitable for commercial use, and is installed like an extension cable between an electrical consumer – as a rule an electrical tool – and the electrical outlet.

Select Measuring Function

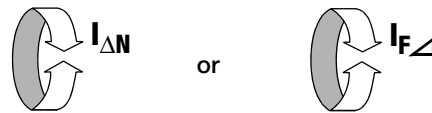

Set Parameter – SRCD / PRCD

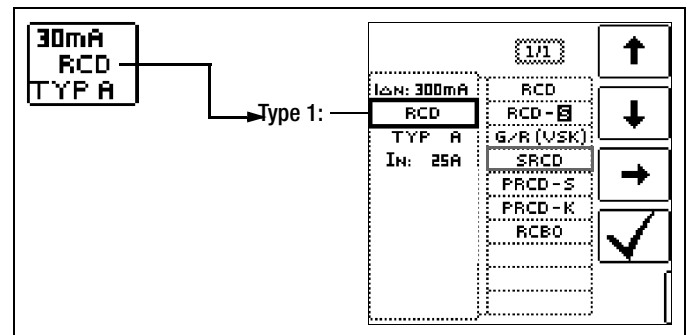

Start Measurement

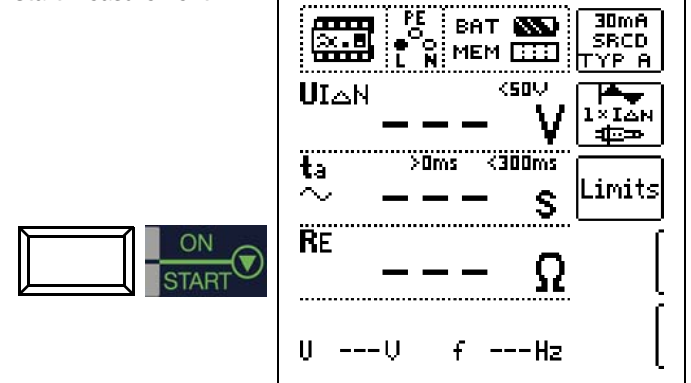

7.3.4 Type G or R RCCB

In addition to standard RCCBs and selective RCDs, the special characteristics of the type G RCCB can also be tested with the test instrument.

The type G RCCB is an Austrian specialty and complies with the ÖVE/ÖNORM E 8601 device standard. Erroneous tripping is minimized thanks to its greater current carrying capacity and short-term delay.

Select Measuring Function

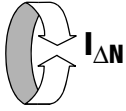

Set Parameter – Type G/R (VSK)

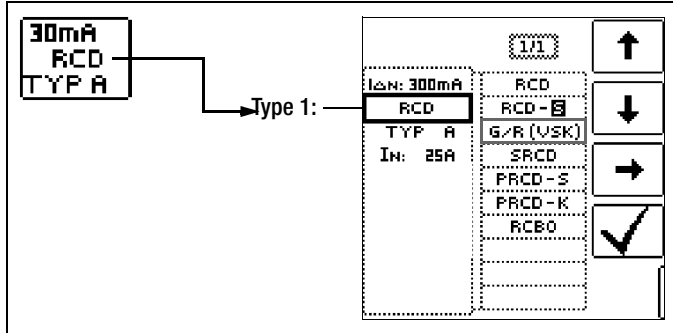

Contact voltage and time to trip can be measured in the G/R-RCD switch position.

Note

It must be observed that time to trip for type G RCCBs may be as long as 1000 ms when measurement is made at nominal residual current. Set the limit value correspondingly.

- Then select $5 \times I_{\Delta N}$ in the menu (this is selected automatically for the G/R setting) and repeat the tripping test beginning with the positive half-wave at 0° and the negative half-wave at 180° . The longer of the two tripping times is decisive regarding the condition of the tested RCCB.

Set the Parameter – Start with Positive or Negative Half-Wave

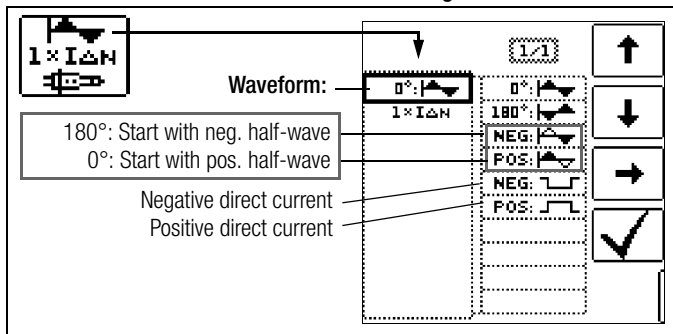

Set the Parameter – 5 Times Nominal Current

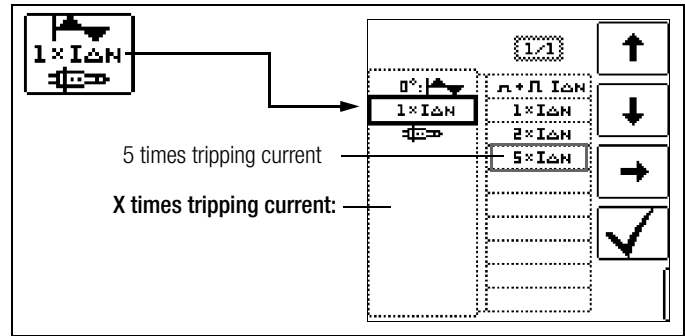

Note

The following restrictions apply to the selection of tripping current multiples relative to nominal current:
500 mA: 1 x, 2 x $I_{\Delta N}$

Start Measurement

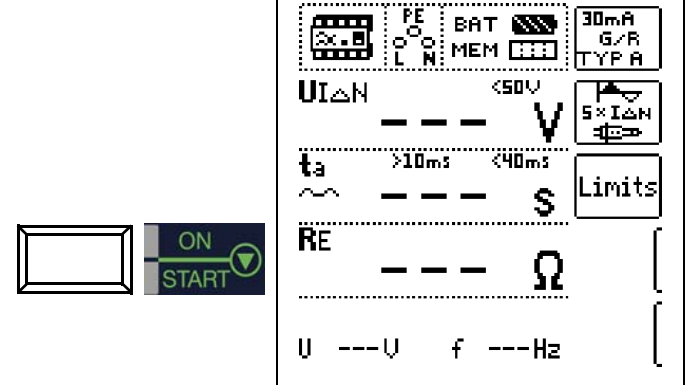

In both cases, tripping time must be between 10 ms (minimum delay time for type G RCCBs) and 40 ms.

Type G RCCBs with other nominal residual current values must be tested with the corresponding parameter setting under menu item $I_{\Delta N}$. In this case as well, the limit value must be appropriately adjusted.

Note

The RCD **S** parameter setting for selective RCCBs is not suitable for type G RCCBs.

7.4 Testing Residual Current Circuit Breakers in TN-S Systems Connection

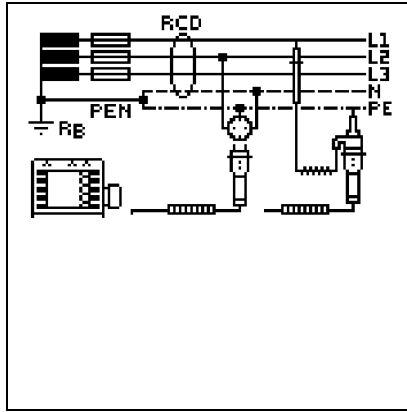

RCCBs can only be used in TN-S systems. An RCCB would not work in a TN-C system because PE is directly connected to the neutral conductor in the outlet (it does not bypass the RCCB). This means that residual current would be returned via the RCCB and would not generate any differential current, which is required in order to trip the RCCB.

As a rule, the display for contact voltage is also 0.1 V, because the nominal residual current of 30 mA together with minimal loop resistance results in a very small voltage value:

$$U_{I\Delta N} = R_E \cdot I_{\Delta N} = 1\Omega \cdot 30\text{mA} = 30\text{mV} = 0,03\text{V}$$

7.5 Testing of RCD Protection in IT Systems with High Cable Capacitance (e.g. in Norway)

The desired system type (TN/TT oder IT) can be selected for RCD test type $U_{I\Delta N}$ ($I_{\Delta N}$, t_a), and for earthing measurement (R_E).

A probe is absolutely essential for measurement in IT systems, because contact voltage $U_{I\Delta N}$ which occurs in these systems cannot otherwise be measured.

After selecting the IT system setting, connection with probe is selected automatically.

Set the Parameter – Select System Type

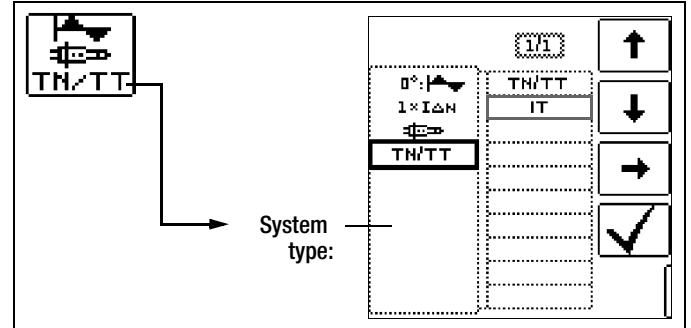

Start Measurement

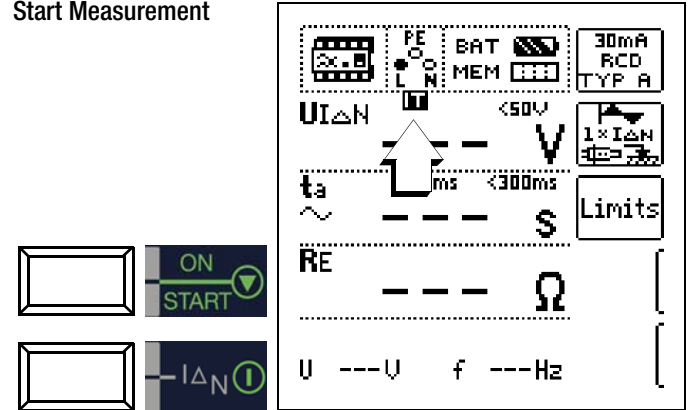

8 Testing of Breaking Requirements Overcurrent Protective Devices, Measurement of Loop Impedance and Determination of Short-Circuit Current (functions Z_{L-PE} and I_K)

Testing of overcurrent protective devices includes visual inspection and measurement. Use the **PROFITEST MASTER** or **SECULIFE IP** to perform measurements.

Measuring Method

Loop impedance Z_{L-PE} is measured and short-circuit current I_K is ascertained in order to determine if the breaking requirements for protective devices have been fulfilled.

Loop impedance is the resistance within the current loop (utility station – phase conductor – protective conductor) when a short-circuit to an exposed conductive part occurs (conductive connection between phase conductor and protective conductor). Short-circuit current magnitude is determined by the loop impedance value. Short-circuit current I_K may not fall below a predetermined value set forth by DIN VDE 0100, so that reliable breaking of the protective device (fuse, automatic circuit breaker) is assured.

Thus the measured loop impedance value must be less than the maximum allowable value.

Tables containing allowable display values for loop impedance and minimum short-circuit current display values for ampere ratings for various fuses and circuit breakers can be found in the help texts and in section 21 beginning of page 88. Maximum device error in accordance with VDE 0413 has been taken into consideration in these tables. See also section 8.2.

In order to measure loop impedance Z_{L-PE} , the instrument uses a test current of 3.7 to 7 A (60 to 550 V) depending on line voltage and line frequency. At 16 Hz, the test has a duration of no more than 1200 ms.

If dangerous contact voltage occurs during measurement (> 50 V), safety shut-down occurs.

The test instrument calculates short-circuit current I_K based on measured loop impedance Z_{L-PE} and line voltage. Short-circuit current calculation is made with reference to nominal line voltage for line voltages which lie within the nominal ranges for 120 V, 230 V and 400 V systems. If line voltage does not lie within these nominal ranges, the instrument calculates short-circuit current I_K based on prevailing line voltage and measured loop impedance Z_{L-PE} .

Select Measuring Function

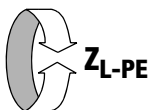

Connection:
Schuko / 3-Pole Adapter

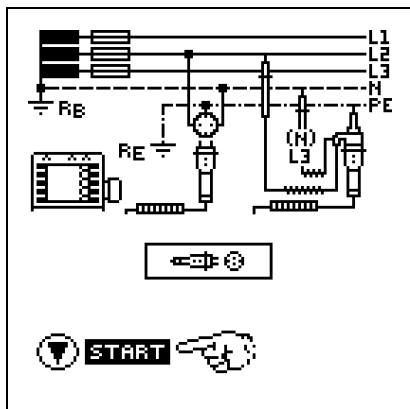

Connection:
2-Pole Adapter

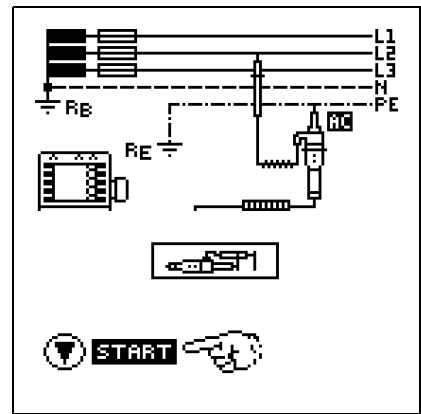

Note

Loop impedance should be measured for each electrical circuit at the farthest point, in order to ascertain maximum loop impedance for the system.

Note

Observe national regulations, e.g. the necessity of conducting measurements without regard for RCCBs in Austria.

3-Phase Connections

Measurement of loop impedance to earth must be performed at all three phase conductors (L1, L2, and L3) for the testing of overcurrent protective devices at three phase outlets.

8.1 Measurements with Suppression of RCD Tripping

Measuring Method with Suppression of RCD Tripping

The test instruments **PROFITEST MTECH+**, **PROFITEST MXTRA** and **SECULIFE IP** make it possible to measure loop impedance in TN systems with type A, F and type AC RCCBs (10, 30, 100, 300, 500 mA nominal residual current).

The test instrument generates a direct current to this end, which saturates the RCCB's magnetic circuit.

The test instrument then superimposes a measuring current which only demonstrates half-waves of like polarity. The RCCB is no longer capable of detecting this measuring current, and is consequently not tripped during measurement.

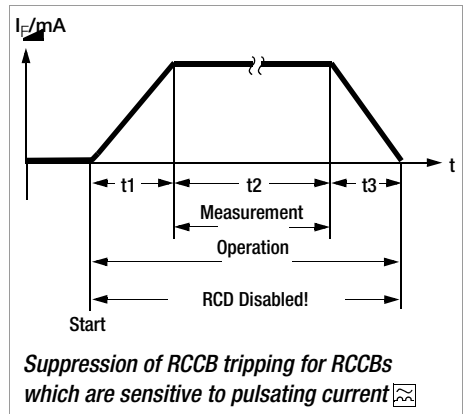

A four conductor measuring cable is used between the instrument and the test plug. Cable and measuring adapter resistance is automatically compensated for during measurement and does not effect measurement results.

Note

A loop impedance measurement by using the method of suppression of RCD tripping can only be performed with type A and F RCDs.

Note

Bias Magnetization

Only AC measurements can be performed with the 2-pole adapter. Suppression of RCD tripping by means of bias magnetization with direct current is only possible via a country-specific plug insert, e.g. SCHUKO, or the 3-pole adapter (neutral conductor necessary).

8.1.1 Measurement with Positive Half-Waves (only MTECH+/MXTRA/SECULIFE IP)

Measurement by means of half-waves plus direct current makes it possible to measure loop impedance in systems which are equipped with RCCBs.

For DC measurement with half-waves you can choose between two alternatives:

- DC-L:** lower premagnetization current allowing for faster measurement
- DC-H:** higher premagnetization current, therefore higher protection against tripping of RCD

Select Measuring Function

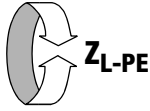

Set Parameters

IN 16A
TYP: B/L
1.5 mm²

Nominal current:
2 ... 160 A, 9999 A

Tripping characteristics:
A, B/L, C/G, D, E, H, K, GL/GG & Factor

Diameter*: 1.5 to 70 sq. mm

Cable types*: NY...-H07...

Number of wires*: 2 to 10-strand

IN: 16A	> 2.0A
5 x IN(B/L)	IN: 3.0A
∅: 1.5 mm ²	IN: 4.0A
NYM-J	IN: 6.0A
3 -ADRIG	IN: 8.0A
	IN: 10A
	IN: 13A
	IN: 16A
	IN: 20A
	IN: 25A

* Parameters used for report generation only which do not influence the measurement

UL<50V
DC

Contact voltage:
Waveform:

Sine
15 mA sinusoidal
DC-L offset and positive half-wave
DC-H offset and positive half-wave

UL: <50V	∅: 15mA
DC-H+	DC-L+
DC-H+	DC-H+

- Sine (full wave)** Setting for electric circuits without RCD
- 15 mA sinusoidal** Setting only for motor protection switch with low nominal current
- DC+half-wave** Setting for electric circuits with RCD

Measurement with country-specific plug insert (e.g. Schuko)

L1-PE

L1-PE

Note
Selecting test probe and Lx-PE reference or AUTO is only relevant for report generation.

Polarity selection

Semiautomatic measurement
See also section 5.8 regarding the AUTO parameter.

AUTO	L1-PE
L1-PE	L2-PE
L1-PE	L3-PE
AUTO	AUTO

Start Measurement



IN 16A
TYP: B/L
1.5 mm²

ZL-PE --- Ω

UL<50V

IK >120A

Limits
Ik: 2/3 Z

L1-PE

U --- V f --- Hz



Semiautomatic Measurement

IN 16A
TYP: B/L
1.5 mm²

ZL-PE --- Ω

UL<50V

IK >120A

Limits
Ik: 2/3 Z

L1-PE

01/03
AUTO

U --- V f --- Hz

8.2 Evaluation of Measured Values

The maximum allowable loop impedance Z_{L-PE} which may be displayed after allowance has been made for maximum operating measurement error (under normal measuring conditions) can be determined with the help of Table 1 on page 88. Intermediate values can be interpolated.

The maximum allowable nominal current for the protective device (fuse or circuit breaker) for a line voltage of 230 V after allowance has been made for maximum measuring error can be determined with the help of Table 6 on page 89 based upon measured short-circuit current (corresponds to DIN VDE 0100 Part 600).

IN 16A
TYP: B/L
1.5 mm²

ZL-PE 539 mΩ

UL<50V

IK >120A

427 A

Limits
Ik: 2/3 Z

L1-PE

U_N 230V f_N 50.0Hz

Special Case: Suppressing Display of the Limit Value

The limit value cannot be ascertained. The inspector is prompted to evaluate the measured values himself, and to acknowledge or reject them with the help of the softkeys.

Measurement passed:
key ✓

Measurement failed:
X key

IN 16A
TYP: B/L
1.5 mm²

ZL-PE 1.17 Ω

UL<50V

IK >120A

196 A

Limits
Ik: 2/3 Z

L1-PE

U_N 230V f_N 50.0Hz

The measured value can only be saved after it has been evaluated.

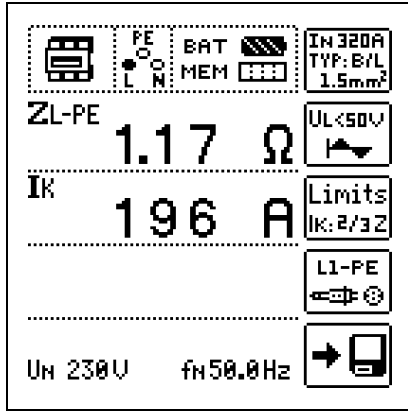

8.3 Settings for Short-circuit current Calculation – Parameter I_K

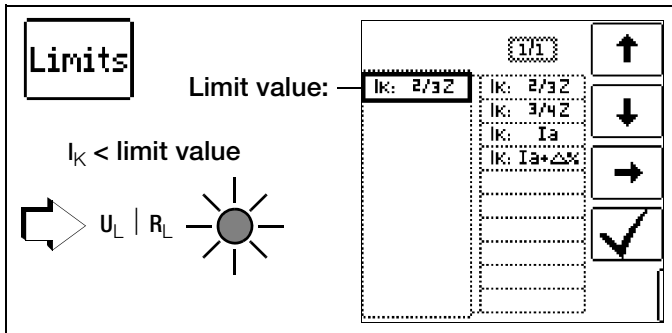

Short-circuit current I_K is used to test shutdown by means of an overcurrent protective device. In order for an overcurrent protective device to be tripped on time, short-circuit current I_K must be greater than tripping current I_a (see table 6 in section 21.1). The variants which can be selected with the "Limits" key have the following meanings:

- I_K : I_a The measured value displayed for I_K is used without any correction to calculate Z_{L-PE} .
- I_K : $I_a + \Delta\%$ The measured value displayed for Z_{L-PE} is corrected by an amount equal to the test instrument's measuring uncertainty in order to calculate I_K .
- I_K : $2/3 Z$ In order to calculate I_K , the measured value displayed for Z_{L-PE} is corrected by an amount corresponding to all possible deviations (these are defined in detail by VDE 0100, part 600, as $Z_{S(m)} \leq 2/3 \times U_0/I_a$).
- I_K : $3/4 Z$ $Z_{S(m)} \leq 3/4 \times U_0/I_a$

- I_K Short-circuit current calculated by the instrument (at nominal voltage)
- Z Fault loop impedance
- I_a Tripping current (see data sheets for circuit breakers / fuses)
- $\Delta\%$ Test instrument intrinsic error

Special Case $I_K > I_{Kmax}$ see page 29.

9 Measuring Line Impedance (Z_{L-N} function)

Measuring Method (internal line resistance measurement)

Supply impedance Z_{L-N} is measured by means of the same method used for loop impedance Z_{L-PE} (see section 8 on page 26). However, the current loop is completed via neutral conductor N rather than protective conductor PE as is the case with loop impedance measurement.

Select Measuring Function

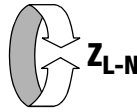

Connection:
Schuko

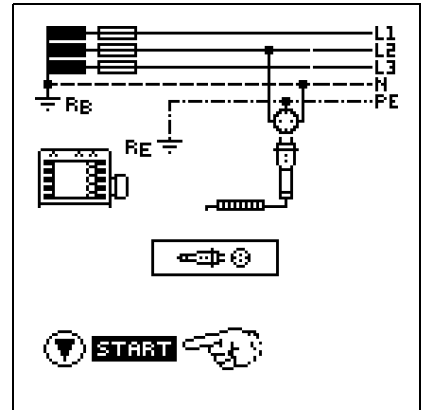

Connection:
2-Pole Adapter

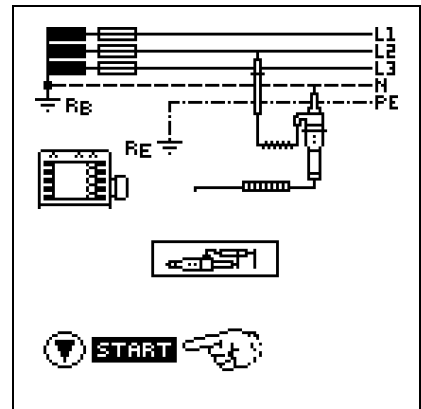

Set Parameters

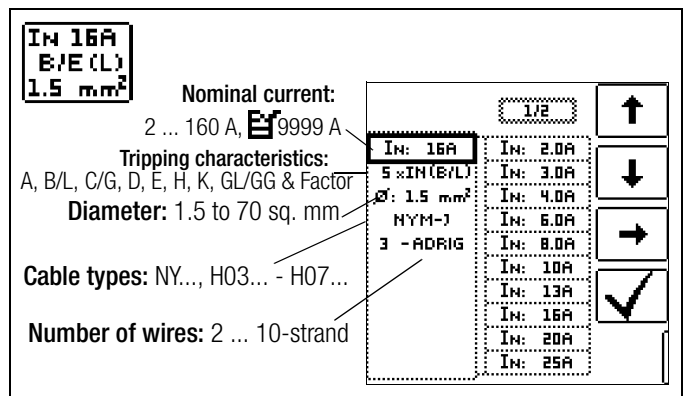

Press the softkey shown at the left in order to switch back and forth between the country-specific plug insert, e.g. SCHUKO, and 2-pole adapter. The selected connection type is displayed inversely (white on black).

01/03
AUTO

Polarity selection

Semiautomatic measurement
See also section 5.8 regarding the **AUTO** parameter. L-PE relationships are not possible here. The neutral L-N relationship is not offered during automatic sequencing to the right of the auto entry!

Start Measurement



ZL-N --- Ω

IK >120A --- A

Limits IK: 2/3Z

L1-N

U ---V f ---Hz

Settings for Short-circuit current Calculation – Parameter I_K

Limits I_K

Limit value: IK: 2/3Z

$I_K < \text{limit value}$

ZL-N 1.16 Ω

IK >120A 199 A

Limits IK: 2/3Z

L1-N

U_N 230V f_N 50.0Hz

Short-circuit current I_K is used to test shutdown by means of an overcurrent protective device. In order for an overcurrent protective device to be tripped on time, short-circuit current I_K must be greater than tripping current I_a (see table 6 in section 21.1). The variants which can be selected with the “Limits” key have the following meanings:

- I_K : I_a The measured value displayed for I_K is used without any correction to calculate Z_{L-PE} .
- I_K : $I_a + \Delta\%$ The measured value displayed for Z_{L-PE} is corrected by an amount equal to the test instrument’s measuring uncertainty in order to calculate I_K .
- I_K : 2/3 Z In order to calculate I_K , the measured value displayed for Z_{L-PE} is corrected by an amount corresponding to all possible deviations (these are defined in detail by VDE 0100, part 600, as $Z_{S(m)} \leq 2/3 \times U_0/I_a$).
- I_K : 3/4 Z $Z_{S(m)} \leq 3/4 \times U_0/I_a$
- I_K Short-circuit current calculated by the instrument (at nominal voltage)
- Z Fault loop impedance
- I_a Tripping current (see data sheet for circuit breakers / fuses)
- $\Delta\%$ Test instrument inherent error

Special case $I_K > I_{Kmax}$

If the value for the short-circuit current is beyond the measured values defined in **PROFITEST MASTER**, it is indicated by **>IK-max**.

In this case, it will be necessary to evaluate the measuring result manually.

ZL-N 1.01 Ω

IK >IK-max 237 A

Limits IK: 2/3Z

L1-N

U_N 230V f_N 50.0Hz

Display of U_{L-N} (U_N / f_N)

If the measured voltage value lies within a range of $\pm 10\%$ of the respective nominal line voltage of 120 V, 230 V or 400 V, the respectively corresponding nominal line voltage is displayed. In the case of measured values outside of the $\pm 10\%$ tolerance, the actual measured value is displayed.

Displaying the Fuse Table

After measurement has been performed, allowable fuse types can be displayed by pressing the HELP key.

The table shows maximum allowable nominal current dependent upon fuse type and breaking requirements.



IK: 199 A

IK: 2/3Z

	I_N	gL/gG	I_N
A	40A	<5s	25A
B/L	25A	<0.4s	16A
E	20A	<0.2s	16A
C/G	13A	<1s	20A
D	6.0A		
K	8.0A		
H	50A		

Key: I_a = breaking current, I_K = short-circuit current, I_N = nominal current, t_A = tripping time

10 Earthing Resistance Measurement (R_E function)

Earthing resistance R_E is important for automatic shutdown in system segments. It must have a low value in order to assure that high short-circuit current flows and the system is shut down reliably by the RCCB in the event of a fault.

Test Setup

Earthing resistance (R_E) is the sum of the earth electrode's dissipation resistance and earth conductor resistance. Earthing resistance is measured by applying an alternating current via the earth conductor, the earth electrode and earth electrode resistance.

This current, as well as voltage between the earth electrode and a probe, are measured.

The probe is connected to the probe connector socket (17) with a 4 mm contact protected plug.

Direct Measurement with Probe (mains powered measurement)

Direct measurement of earthing resistance R_E is only possible within a measuring circuit which includes a probe. However, this means that the probe and reference earth must be of like potential, i.e. that they are positioned outside of the potential gradient area. The distance between the earth electrode and the probe should be at least 20 m.

Measurement without Probe (mains powered measurement)

In many cases, especially in extremely built-up areas, it is difficult, or even impossible, to set a measuring probe. In such cases, earthing resistance can be measured without a probe. In this case, however, the resistance values for the operational earth electrode R_B and phase conductor L are also included in the measurement results.

Measuring Method (w. probe) (mains powered measurement)

The instrument measures earthing resistance R_E by means of the ammeter-voltmeter test.

Resistance R_E is calculated from the quotient of voltage U_E and current I_E where U_E is between the earth electrode and the probe. The test current which is applied to earthing resistance is controlled by the instrument (see section 19, "Characteristic Values", beginning on page 82 for pertinent values).

A voltage drop is generated which is proportional to earthing resistance.

Note

Measurement cable and measuring adapter resistance are compensated for automatically during measurement and have no effect on measurement results.

If dangerous contact voltages occur during measurement (> 50 V), the measurement is interrupted and safety shutdown occurs.

Probe resistance does not effect measurement results and may be as high as 50 k Ω .



Attention!

The probe is part of the measuring circuit and may carry a current of up to 3.5 mA in accordance with VDE 0413.

Measurement with or without earth electrode voltage depending upon entered parameters and the selected type of connection:

RANGE	Connection	Measuring Functions
xx Ω / xx k Ω		No probe measurement No U_E measurement
10 Ω / U_E *		Probe measurement activated U_E is measured
xx Ω / xx k Ω *		Probe measurement activated No U_E measurement
		Clamp measurement activated No U_E measurement

* This parameter results in automatic selection of probe connection.

Measuring Method with Suppression of RCD Tripping (mains powered earthing measurement)

The test instruments PROFITEST MTECH+, PROFITEST MXTRA and SECULIFE IP make it possible to measure loop impedance in TN systems with type A, F and type AC RCCBs (10, 30, 100, 300, 500 mA nominal residual current).

The test instrument generates a direct current to this end, which saturates the RCCB's magnetic circuit.

The test instrument then superimposes a measuring current which only demonstrates half-waves of like polarity. The RCCB is no longer capable of detecting this measuring current, and is consequently not tripped during measurement.

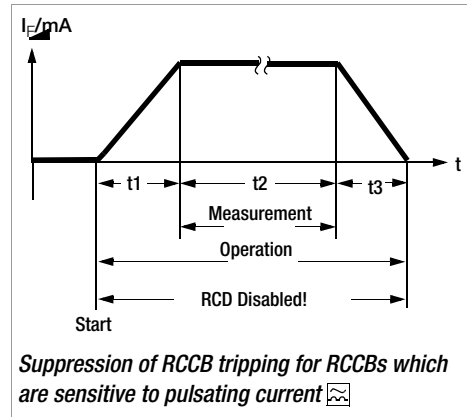

A four conductor measuring cable is used between the instrument and the test plug. Cable and measuring adapter resistance is automatically compensated for during measurement and does not effect measurement results.



Note

Bias Magnetization

Only AC measurements can be performed with the 2-pole adapter. Suppression of RCD tripping by means of bias magnetization with direct current is only possible via a country-specific plug insert, e.g. SCHUKO, or the 3-pole adapter (neutral conductor necessary).

Limit Values

Earthing resistance (earth coupling resistance) is determined primarily by the electrode's contact surface and the conductivity of the surrounding earth.



The specified limit value depends on the type of electrical system and its shutdown conditions in consideration of maximum contact voltage.

Evaluation of Measured Values

The maximum allowable displayed resistance values which assure that the required earthing resistance is not exceeded, and for which maximum device operating error has already been taken into consideration (at nominal conditions of use), can be determined with the help of Table 2 on page 88. Intermediate values can be interpolated.

10.1 Earthing Resistance Measurement – Mains Operated

The following types of measurement or connection are possible:

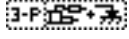
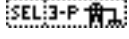
-  2-pole measurement via 2-pole adapter
-  2-pole measurement via earthing contact plug (not possible in IT systems)
-  3-pole measurement via 2-pole adapter and probe
-  Selective measurement: 2-pole measurement with probe and current clamp sensor

At left in figure:

2-pole measuring adapter for contacting PE and L measuring points



At right in figure:

The PRO-Schuko measuring adapter can be used as an alternative.

Select Measuring Function

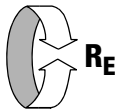

Select Operating Mode



The selected operating mode is displayed inversely: mains~ in white against a black background.

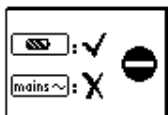

Battery powered measurement is not possible:

The error message shown at the left appears if the selected connection type is inappropriate for the operating mode.

Special Case: Manual Measuring Range Selection (test current selection)

($R \neq \text{AUTO}$, $R = 10 \text{ k}\Omega$ (4 mA), $1 \text{ k}\Omega$ (40 mA), 100Ω (0.4 A), 10Ω (3.7 ... 7 A), $10 \Omega/U_E$)



Note

When the measuring range is selected manually, accuracy values are only valid starting at 5% of the upper limit range value (except for the 10Ω range; separate display for small values).

Set Parameters

- Measuring range:** AUTO, $10 \text{ k}\Omega$ (4 mA), $1 \text{ k}\Omega$ (40 mA), 100Ω (0.4 A), 10Ω (> 3.7 A)
In systems with RCCBs, resistance or test current must be selected such that it is less than tripping current ($\frac{1}{2} I_{\Delta N}$).
- Contact voltage:** UL < 25 V, < 50 V, < 65 V, see section 5.7 regarding freely selectable voltage.
- Transformer ratio:** depends on utilized current clamp sensor
- Connection type:** 2-pole adapter, 2-pole adapter + probe, 2-pole adapter + clamp meter
- Type of system:** TN or TT
- Test current waveform**

See section 10.4 through section 10.6 regarding advisable parameters for the respective measurement and connection types.

Perform Measurements

See section 10.4 through section 10.6.

10.2 Earthing Resistance Measurement – Battery Powered (only MPRO & MXTRA)

The 5 following types of measurement or connection are possible:



-  3-Pole measurement via PRO-RE adapter
-  4-Pole measurement via PRO-RE adapter
-  Selective measurement with clamp meter (4-pole) via PRO-RE adapter
-  2-clamp measurement via PRO-RE/2 adapter
-  Measurement of soil resistivity ρ_E via PRO-RE adapter

Figure at right:

PRO-RE adapter for connecting earth electrode, auxiliary earth electrode, probe and auxiliary probe to the test instrument for 3/4-pole measurement, selective measurement and measurement of soil resistivity

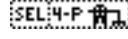
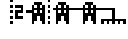
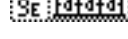

Figure at right:

PRO-RE/2 measuring adapter as accessory for connecting the E-Clip 2 generator clamp for 2-clamp measurement and earth loop resistance measurement.



Select Measuring Function



Select Operating Mode



The selected operating mode is displayed inversely: white battery icon against black background.

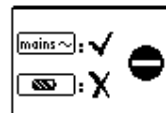

Mains powered measurement is not possible:

The error message shown at the left appears if the selected connection type is inappropriate for the operating mode.

Set Parameters

- Measuring range:** AUTO, $50 \text{ k}\Omega$, $20 \text{ k}\Omega$, $2 \text{ k}\Omega$, 200Ω , 20Ω
- Current clamp sensor transformer ratio:**
1:1 (1 V/A), 1:10 (100 mV/A), 1:100 (10 mV/A), 1:1000 (1 mV/A)
- Connection type:** 3-pole, 4-pole, selective, 2-clamp, ρ_E (Rho)
- Distance d (for measuring ρ_E):** xx m

See section 10.7 through section 10.11 regarding advisable parameters for the respective measurement and connection types.

Perform Measurements

See section 10.7 through section 10.11.

10.3 Earthing Resistance, Mains Powered – 2-Pole Measurement with 2-Pole Adapter or Country-Specific Plug (Schuko) without Probe

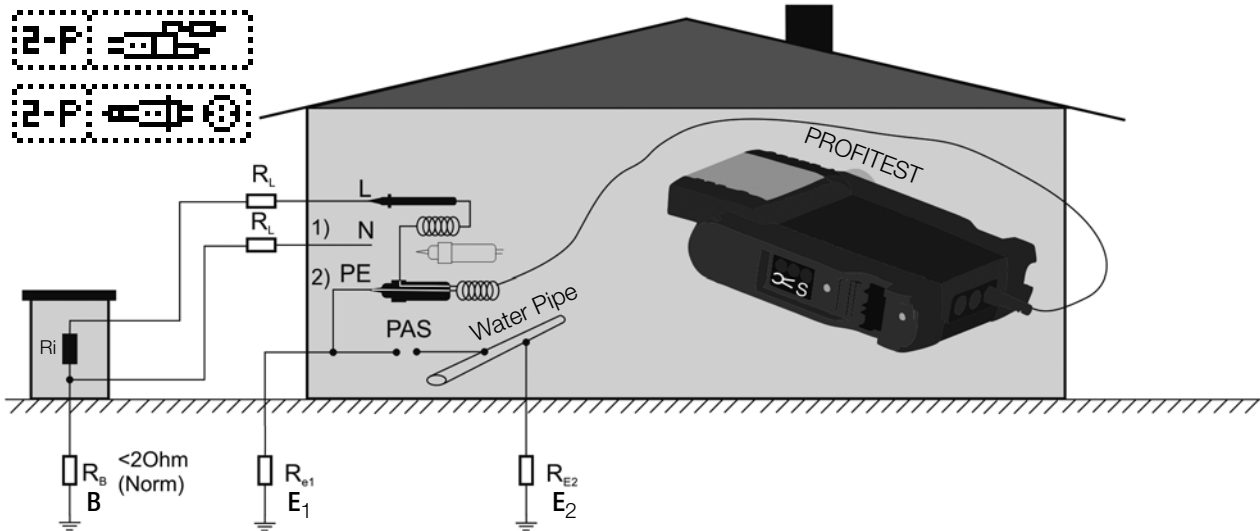

Key

- R_B Operational earth
- R_E Earthing resistance
- R_i Internal resistance
- R_X Earthing resistance through equipotential bonding systems
- R_S Probe resistance
- PAS Equipotential bonding busbar
- $R_{E_{\downarrow}}$ Overall earthing resistance ($R_{E1} // R_{E2} // \text{water pipe}$)

In the event that it is impossible to set a probe, earthing resistance can be estimated by means of an "earth loop resistance measurement" without probe.

The measurement is performed exactly as described in section 10.4, "Earthing Resistance Measurement, Mains Powered – 3-Pole Measurement: 2-Pole Adapter with Probe", beginning on page 33. However, no probe is connected to the probe connector socket (17).

The resistance value $R_{E_{Loop}}$ obtained with this measuring method also includes operational earth electrode resistance R_B and resistance at phase conductor L. These values must be deducted from the measured value in order to determine earthing resistance.

If conductors of equal cross section are assumed (phase conductor L and neutral conductor N), phase conductor resistance is half as great as supply impedance Z_{L-N} (phase conductor + neutral conductor). Supply impedance can be measured as described in section 9 beginning of page 28. In accordance with DIN VDE 0100, operational earth electrode R_B must lie within a range of "0 Ω to 2 Ω ".

- 1) Measurement: Z_{L-N} amounts to $R_i = 2 \cdot R_L$
- 2) Measurement: Z_{L-PE} amounts to $R_{E_{Loop}}$
- 3) Calculation: R_{E1} amounts to $Z_{L-PE} - 1/2 \cdot Z_{L-N}$; where $R_B = 0$

The value for operational earth conductor resistance R_B should be ignored in the calculation of earthing resistance, because it is generally unknown.

The calculated earthing resistance thus includes operational earth conductor resistance as a safety factor.

In parameter setting  steps 1 to 3 are performed automatically by the test instrument.

Select Measuring Function



Select Operating Mode



Set Parameters

- Measuring range:** AUTO, 10 k Ω (4 mA), 1 k Ω (40 mA), 100 Ω (0.4 A), 10 Ω (3.7 ... 7 A). In systems with RCCBs, resistance or test current must be selected such that it is less than tripping current ($1/2 I_{\Delta N}$).
- Connection type:** 2-pole adapter
- Contact voltage:** UL < 25 V, < 50 V, < 65 V
- Test current waveshape:** Sinusoidal (full-wave), 15 mA sinusoidal (full-wave), DC offset and positive half-wave
- System type:** TN/TT, IT
- Transformer ratio:** irrelevant in this case

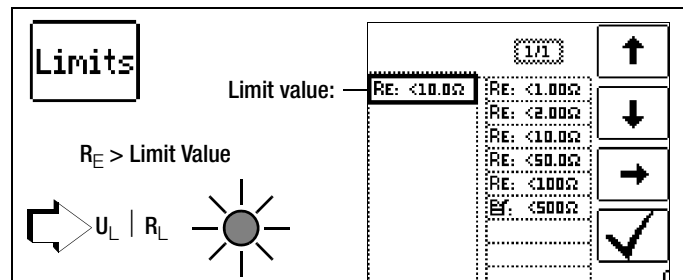

Start Measurement

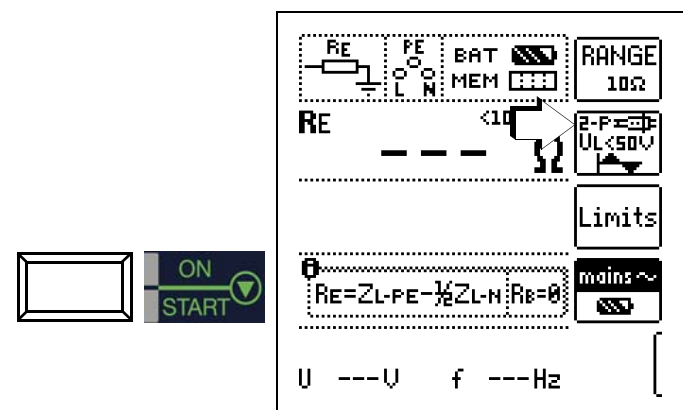
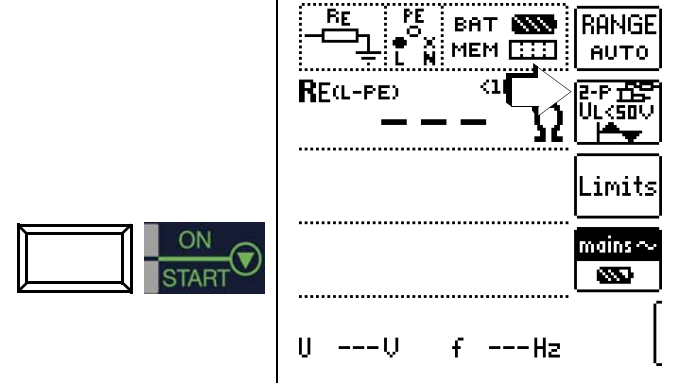

10.4 Earthing Resistance Measurement, Mains Powered – 3-Pole Measurement: 2-Pole Adapter with Probe

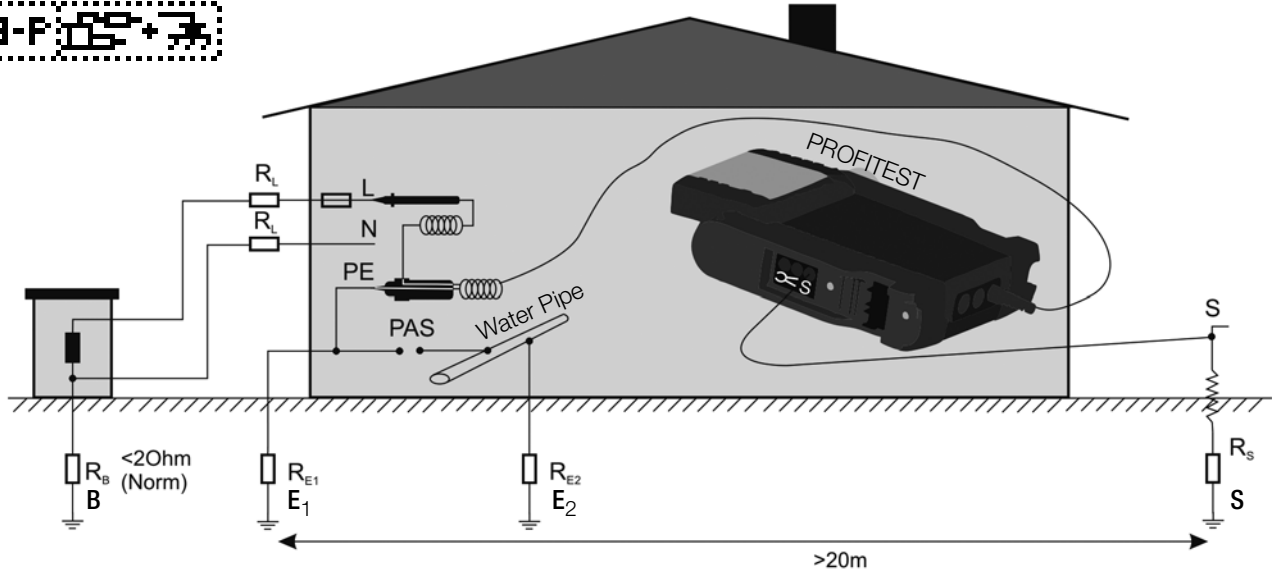

Key

- R_B Operational earth electrode
- R_E Earthing resistance
- R_X Earthing resistance through equipotential bonding systems
- R_S Probe resistance
- PAS Equipotential bonding busbar
- $R_{E_{\downarrow}}$ Overall earthing resistance ($R_{E1} // R_{E2} // \text{water pipe}$)

Measurement of R_E ($R_{E1} = \frac{U_{\text{Probe}}}{I}$)

Set Parameters

- Measuring range:** AUTO, 10 k Ω (4 mA), 1 k Ω (40 mA), 100 Ω (0.4 A), 10 Ω (3.7 ... 7 A)
In systems with RCCBs, resistance or test current must be selected such that it is less than tripping current ($\frac{1}{2} I_{\Delta N}$).
- Connection type:** 2-pole adapter + probe
- Contact voltage:** UL < 25 V, < 50 V, < 65 V, see section 5.7 regarding freely selectable voltage.
- Test current waveshape:** Sinusoidal (full-wave), 15 mA sinusoidal (full-wave), DC offset and positive half-wave
- System type:** TN/TT, IT
- Transformer ratio:** irrelevant in this case

Select Measuring Function

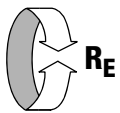

Select Operating Mode

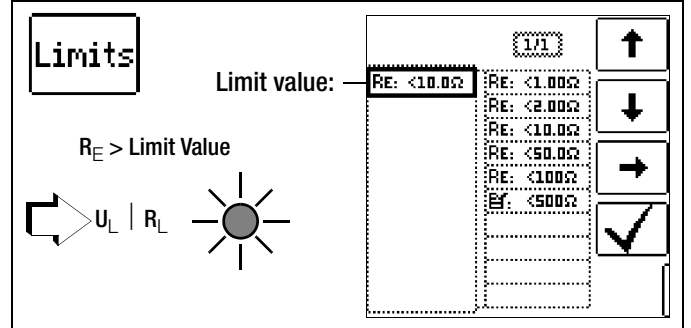

Connection

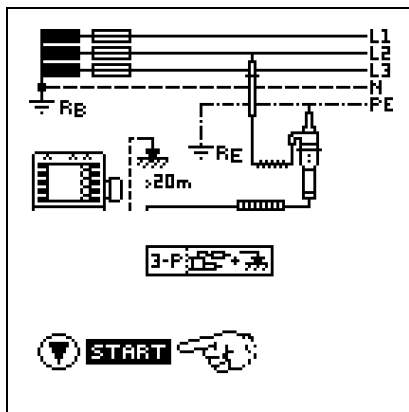

2-pole adapter and probe are connected

Start Measurement

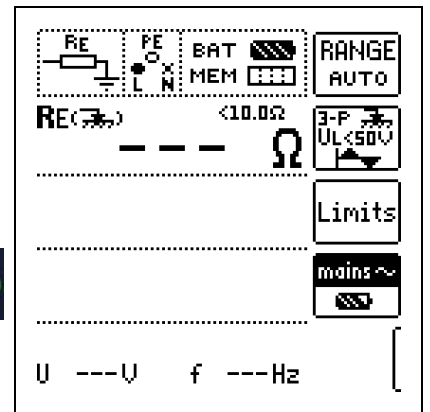

Note

The following diagram appears if the 2-pole adapter is connected incorrectly.

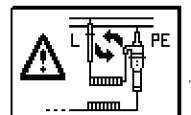

10.5 Earthing Resistance Measurement, Mains Powered – Measurement of Earth Electrode Voltage (U_E function)

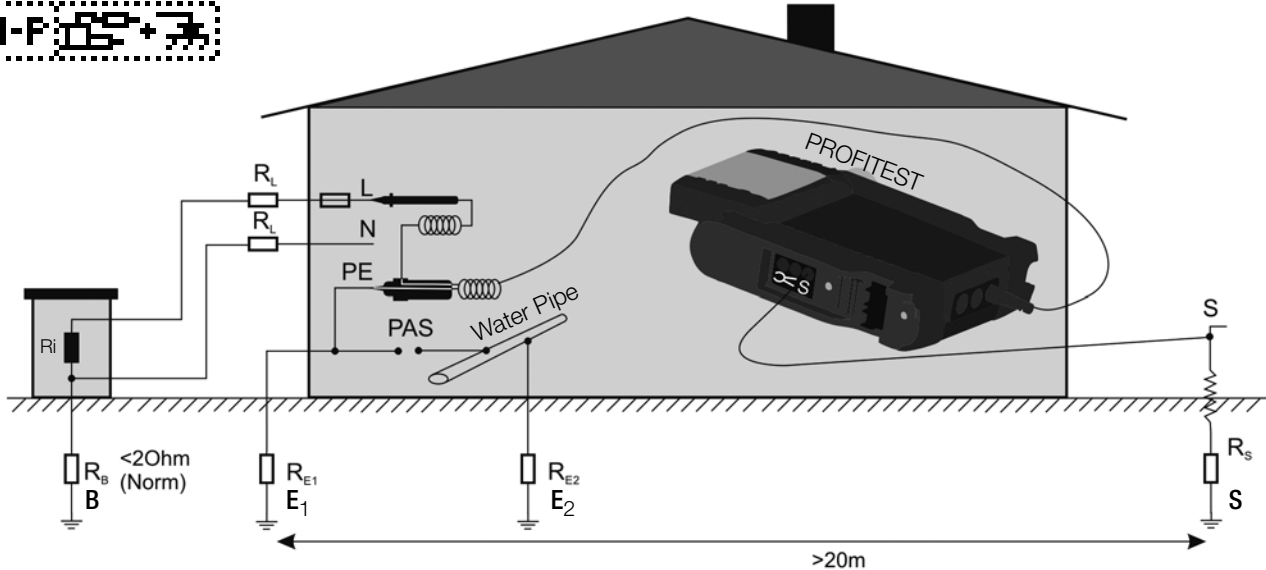

This measurement is only possible with a probe (see section 10.4). Earth electrode potential U_E is the voltage which occurs at the earth electrode between the earth electrode terminal and reference earth if a short-circuit occurs between the phase conductor and the earth electrode. Measurement of earth electrode potential is required by Swiss standard NIV/NIN SEV 1000.

Measuring Method

In order to determine earth electrode potential, the instrument first measures earth electrode loop resistance R_{ELoop} , and immediately thereafter earthing resistance R_E . The instrument stores both values and then calculates earth electrode potential with the following equation:

$$U_E = \frac{U_N \cdot R_E}{R_{ELoop}}$$

The calculated value is displayed at the display panel.

Select Measuring Function



Select Operating Mode



Select measuring range



Connection

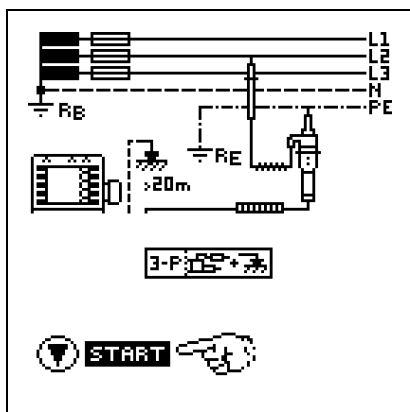

Set Parameters

- Measuring range:** $10 \Omega / U_E$
- Connection type:** 2-pole adapter + probe
- Contact voltage:** UL < 25 V, < 50 V, < 65 V, see section 5.7 regarding freely selectable voltage.
- Test current waveshape:** sinusoidal only in this case (full-wave)!
- System type:** TN/TT, IT
- Transformer ratio:** irrelevant in this case

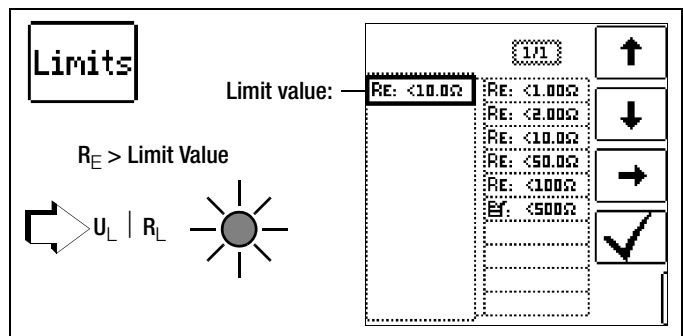

Start Measurement

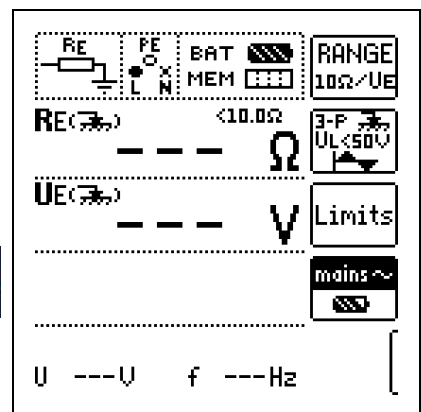

Note

The following diagram appears if the 2-pole adapter is connected incorrectly.

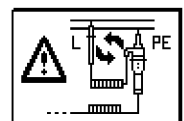

2-pole adapter and probe are connected.

10.6 Earthing Resistance Measurement, Mains Powered – Selective Earthing Resistance Measurement with Current Clamp Sensor as Accessory

As an alternative to the conventional measuring method, measurement can also be performed with a current clamp sensor.

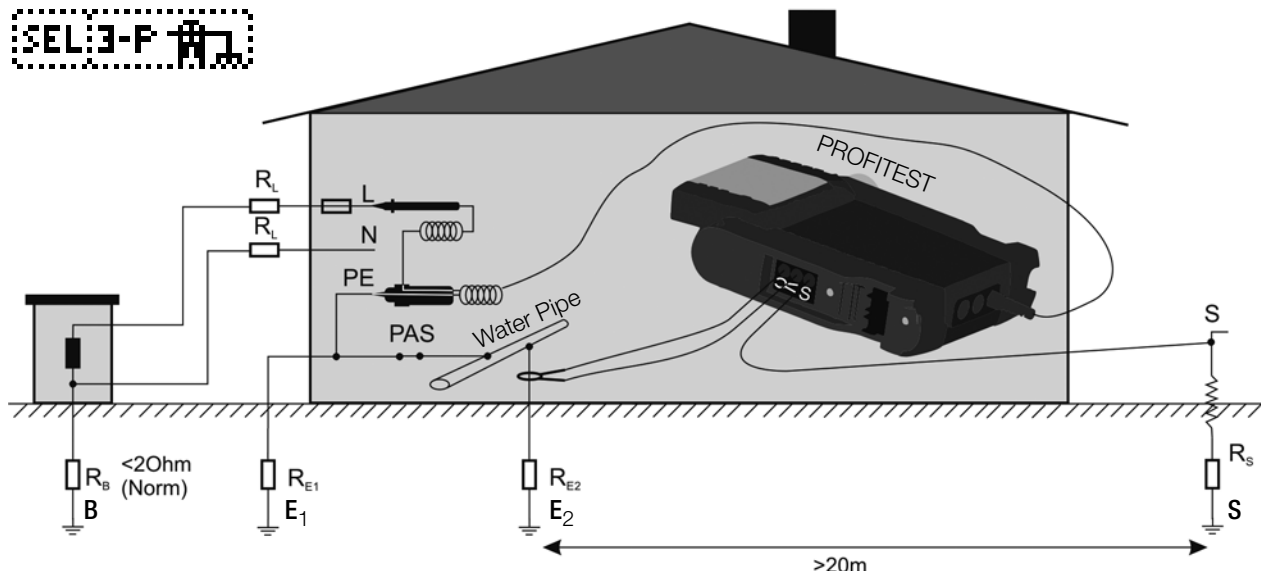

Key

- R_B Operational earth
- R_E Earthing resistance
- R_L Cable resistance
- R_X Earthing resistance through equipotential bonding systems
- R_S Probe resistance
- PAS Equipotential bonding busbar
- $R_{E_{\downarrow}}$ Overall earthing resistance ($R_{E1} // R_{E2} // \text{water pipe}$)

Measurement without clamp: $R_E = R_{E1} // R_{E2}$

Measurement with clamp: $R_E = R_{E2} = \left(\frac{U_{\text{Probe}}}{I_{\text{Clamp}}} \right)$

Select Measuring Function



Select Operating Mode



Connection

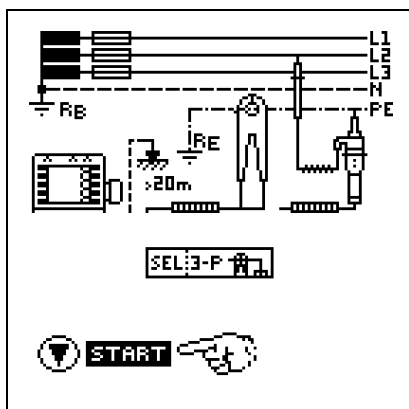

Set Parameters at Tester

- Measuring range** (test current selection):
1 k Ω (40 mA), 100 Ω (0.4 A), 10 Ω (3.7 ... 7 A)
In the case of systems with RCCBs, the DC + functions can be selected (only in the 10 Ω range and only with the METRAFLEX P300).
- Connection type**: 2-pole adapter + clamp
After parameter selection: automatic setting to 10 Ω measuring range and 1 V/A or 1000 mV/A transformer ratio
- Contact voltage**: UL < 25 V, < 50 V, < 65 V, see section 5.7 regarding freely selectable voltage.
- Test current waveshape**:
Sinusoidal (full-wave), DC offset and positive half-wave
- System type**: TN/TT, IT
- Current clamp sensor transformation ratio: see table below

Set Parameters at Current Clamp Sensor

- Current clamp sensor measuring range**: see table below

Selecting a Measuring Range at the Current Clamp Sensor

Tester	METRAFLEX P300 Clamp		Tester
Transformation Ratio Parameter	Switch	Measuring Range	Measuring Range
1:1 1 V / A	3 A (1 V/A)	3 A	0.5 ... 100 mA
1:10 100 mV / A	30 A (100 mV/A)	30 A	5 ... 999 mA
1:100 10 mV / A	300 A (10 mV/A)	300 A	0.05 ... 10 A

Important Instructions for Use of the Current Clamp Sensor

- Use only the METRAFLEX P300 or the Z3512A current clamp sensor for this measurement.
- Read and adhere to the **operating instructions** for the METRAFLEX P300 current clamp sensor, as well as the safety precautions included therein.
- Observe **direction of current flow** (see arrow on the current clamp sensor).
- Use the **clamp in the permanently connected** state. The sensor may not be moved during measurement.
- The current clamp sensor may only be used at an adequate distance from **powerful extraneous fields**.
- Before use, always inspect the electronics housing, the connector cable and the current sensor for damage.

2-pole adapter, clamp and probe are connected.

- In order to prevent electric shock, keep the surface of the METRAFLEX clean and free of contamination.
- Before use, make sure that the flexible current sensor, the connector cable and the electronics housing are dry.

Start Measurement

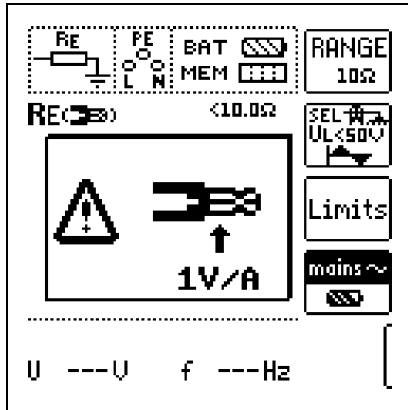

In the event that you have changed the transformation ratio at the test instrument, a pop-up window appears indicating that this new setting also has to be entered to the connected current clamp sensor.

i: Note regarding currently selected transformation ratio at the tester

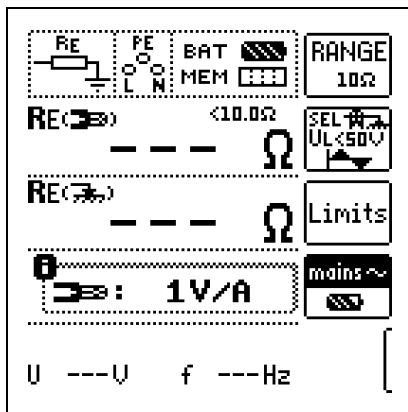

RE_{Clamp} : Selective earthing resistance measured via clamp
 RE_{Probe} : Total earthing resistance measured via probe, comparative value

Note

The following diagram appears if the 2-pole adapter is connected incorrectly.

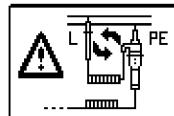

10.7 Earthing Resistance Measurement, Battery Operated – 3-Pole (only MPRO & MXTRA)

3-Wire Method

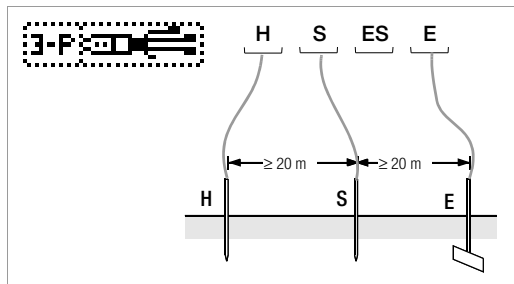
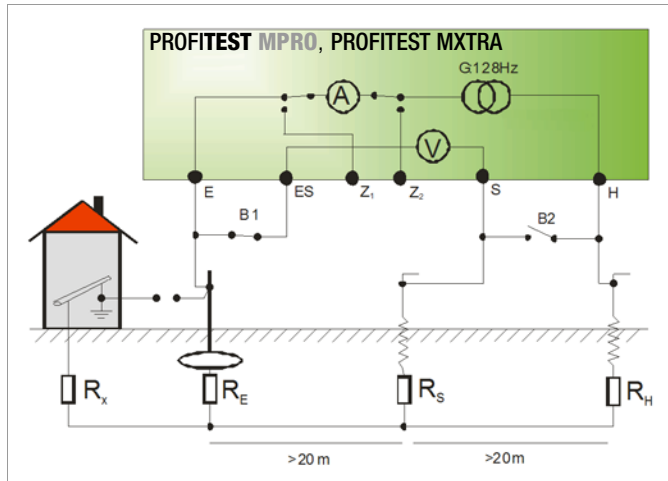

Measurement of Earthing Resistance with 3-Wire Method

Connection

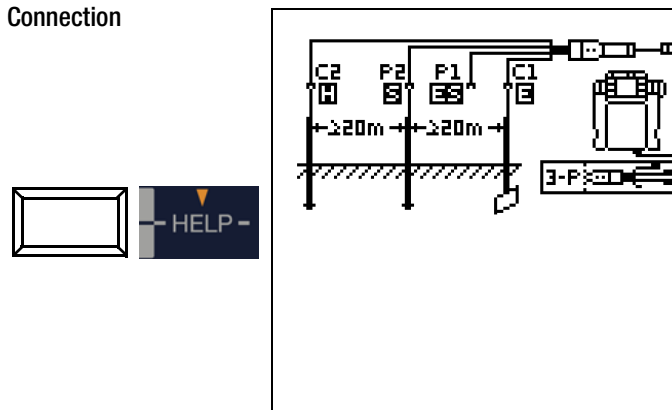

- Position the spikes for the probe and the auxiliary electrode at least 20, respectively 40 meters from the electrode (see figure above).
- Make sure that no excessively high contact resistances occur between the probe and the ground.
- Attach the **PRO-RE adapter (Z501S)** to the test plug.
- Connect the probe, the auxiliary electrode and the electrode via the 4 mm banana plug sockets at the **PRO-RE adapter**. In doing so, observe labeling on the banana plug sockets. Terminal ES/P1 is not connected.

The resistance of the measurement cable to the earth electrode is incorporated directly into the measurement results.

In order to keep error caused by measurement cable resistance as small as possible, a short connector cable with large cross-section should be used between the earth electrode and terminal "E" for this measuring method.

Note

The measurement cables must be well insulated in order to prevent shunting. In order to keep the influence of possible coupling to a minimum, the measurement cables should not cross each other or run parallel to each other over any considerable distance.

Select Measuring Function



Select Operating Mode



The selected operating mode is displayed inversely: white battery icon against black background.

Set Parameters

- Measuring range:** AUTO, 50 k Ω , 20 k Ω , 2 k Ω , 200 Ω , 20 Ω
- Connection type:** 3-pole
- Transformer ratio:** irrelevant in this case
- Distance d (for measuring ρ_E):** irrelevant in this case

Start Measurement

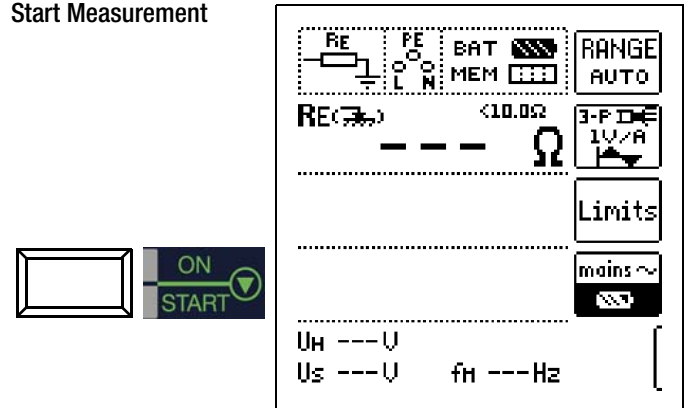

10.8 Earthing Resistance Measurement, Battery Operated – 4-Pole (only MPRO & MXTRA)

4-Wire Method

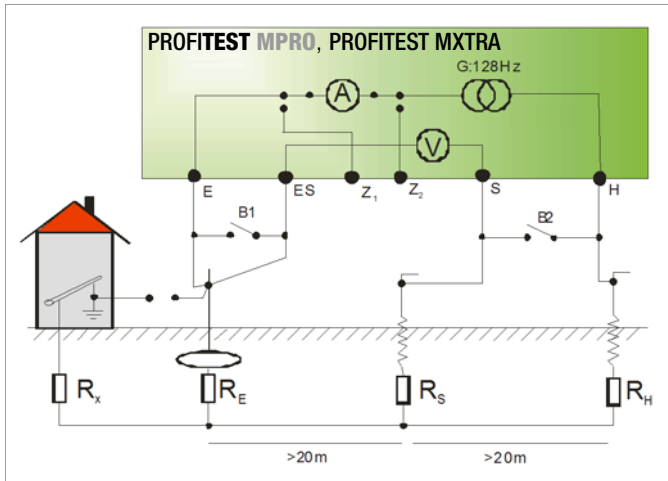

The 4-wire method is used in the case of high cable resistance between the earth electrode and the instrument terminal. The resistance of the cable between the earth electrode and the “E” terminal at the instrument is measured in this case.

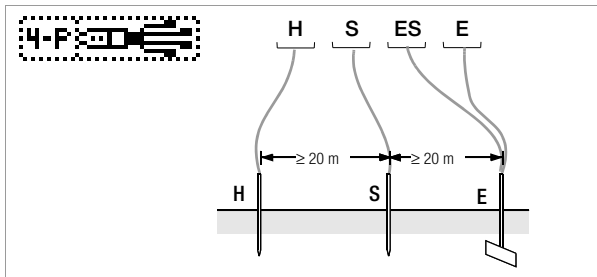
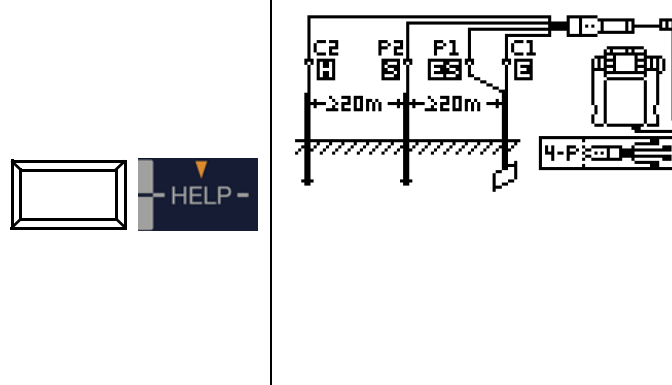

Figure 10.8.1: Measurement of Earthing Resistance with 4-Wire Method

Connection



- Position the spikes for the probe and the auxiliary electrode at least 20 meters from the electrode (see figure above).
- Make sure that no excessively high contact resistances occur between the probe and the ground.
- Attach the **PRO-RE adapter (Z501S)** to the test plug.
- Connect the probes, the auxiliary electrode and the electrode via the 4 mm banana plug sockets at the **PRO-RE adapter**. In doing so, observe labeling on the banana plug sockets.

Note

In the case of the 4-wire method, the earth electrode is connected to the “E” and “ES” terminals with two separate measurement cables, the probe is connected to the “S” terminal and the auxiliary earth electrode is connected to the “H” terminal.

Note

The measurement cables must be well insulated in order to prevent shunting. In order to keep the influence of possible coupling to a minimum, the measurement cables should not cross each other or run parallel to each other over any considerable distance.

Select Measuring Function



Select Operating Mode



The selected operating mode is displayed inversely: white battery icon against black background.

Set Parameters

- Measuring range:** AUTO, 50 k Ω , 20 k Ω , 2 k Ω , 200 Ω , 20 Ω
- Connection type:** 4-pole
- Transformer ratio:** irrelevant in this case
- Distance d (for measuring ρ_E):** irrelevant in this case

Start Measurement

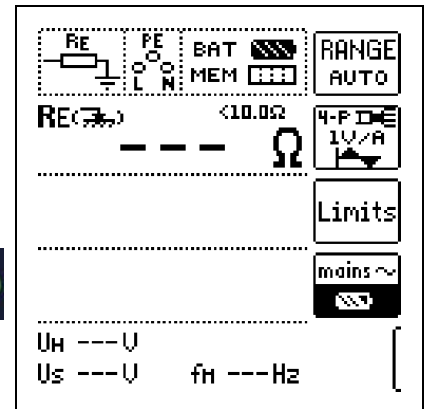

Potential Gradient Area

Information regarding suitable positioning of the probe and the auxiliary earth electrode can be obtained by observing voltage characteristics or dissipation resistance in the ground.

The measuring current from the earth tester which flows via the earth electrode and the auxiliary earth electrode causes a given potential distribution in the form of a potential gradient area (see also Figure 10.8.3: on page 39). Resistance distribution is analogous to potential distribution.

Dissipation resistance of the earth electrode and the auxiliary earth electrode differs as a rule. The potential gradient area and the resistance gradient area are thus not symmetrical.

Dissipation Resistance of Small Scope Earth Electrodes

The arrangement of the probe and the auxiliary earth electrode is very important for correct determination of the dissipation resistance of earth electrodes.

The probe must be positioned between the earth electrode and the auxiliary earth electrode within the so-called neutral zone (reference earth) (see also Figure 10.8.2: on page 39).

The voltage or resistance curve is thus nearly horizontal within the neutral zone.

Proceed as follows in order to select suitable probe and auxiliary earth electrode resistances:

- Drive the auxiliary earth electrode into the ground at a distance of roughly 40 meters from the earth electrode.

- Position the probe halfway between the earth electrode and the auxiliary earth electrode and determine earthing resistance.
- Reposition the probe 2 to 3 meters closer to the earth electrode, and then 2 to 3 meters closer to the auxiliary earth electrode and measure earthing resistance in each position.

If all 3 measurements result in the same measured value, this is the correct earthing resistance. The probe is in the neutral zone. However, if the three measured values for earthing resistance differ from each other, either the probe is not located in the neutral zone, or the voltage or resistance curve is not horizontal at the point at which the probe has been inserted.

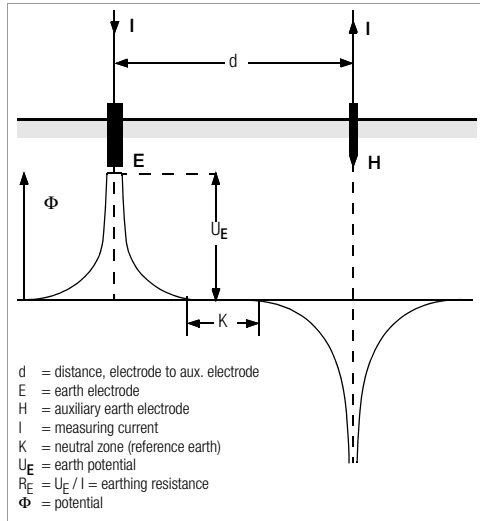

Figure 10.8.2: Voltage Curve in Homogenous Earth between Earth Electrode E and Auxiliary Earth Electrode H

Correct measurements can be obtained in such cases by either increasing distance between the earth electrode and the auxiliary earth electrode, or by moving the probe to the perpendicular bisector between the earth electrode and the auxiliary earth electrode (see also Figure 10.8.3:). When the probe is moved to the perpendicular bisector, its location is removed from the sphere of influence of the two potential gradient areas caused by the earth electrode and the auxiliary earth electrode.

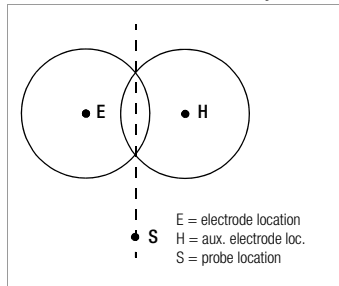

Figure 10.8.3: Probe Distance S Outside of the Overlapping Potential Gradient Areas on the Perpendicular Bisector of Earth Electrode E and Auxiliary Earth Electrode H

Dissipation Resistance of Large Scope Earthing Systems

Significantly large distances to the probe and the auxiliary earth electrode are required for measuring large scope earthing systems. Calculations are based on 2½ or 5 times the value of the earthing system's largest diagonal.

Large scope earthing systems of this sort often demonstrate dissipation resistances of only a few ohms, which makes it especially important to position the measuring probe within the neutral zone. The probe and the auxiliary earth electrode should be positioned at a right angle to the direction of the earthing system's largest linear expansion. Dissipation resistance must be kept small. If necessary, several earth spikes must be used at a distance of 1 to 2 m from each other and connected to this end.

However, in actual practice large measuring distances are frequently not possible to due difficult terrain. If this is the case, proceed as shown in Figure 10.8.4:.

- Auxiliary earth electrode H is positioned as far from possible from the earthing system.
- The area between the earth electrode and the auxiliary earth electrode is sampled in equal steps of 5 meters each.
- Measured resistance values are displayed as a table, and then plotted graphically as depicted in Figure 10.8.4: (curve I).

If a line parallel to the abscissa is drawn through inflection point S1, this line divides the resistance curve into two parts. Measured at the ordinate the bottom part results in sought dissipation resistance of the earth electrode $R_{A/E}$, and the top value equals dissipation resistance of the auxiliary earth electrode $R_{A/H}$. With a measurement setup of this type, dissipation resistance of the auxiliary earth electrode should be less than 100 times the dissipation resistance of the earth electrode.

In the case of resistance curves without a well defined horizontal area, measurement should be double checked after repositioning the auxiliary earth electrode. This additional resistance curve must be entered to the first diagram with a modified abscissa scale such that the two auxiliary earth electrode locations are superimposed. The initially ascertained dissipation resistance value can be checked with inflection point S2 (see Figure 10.8.4:).

Notes Regarding Measurement in Difficult Terrain

In extremely unfavorable terrain (e.g. sandy soil after a lengthy period without rain), auxiliary earth electrode and probe resistance can be reduced to permissible values by watering the ground around the auxiliary earth electrode and the probe with soda water or salt water. If this does not suffice, several earth spikes can be parallel connected to the auxiliary earth electrode.

In mountainous terrain or in the case of very rocky subsoil where earth spikes cannot be driven into the ground, wire grates with a mesh size of 1 cm and a surface area of about 2 square meters can be used. These grates are laid flat onto the ground, are wetted with soda water or salt water and may also be weighted down with sacks full of moist earth.

Curve I (KI)		Curve II (KII)	
m	W	m	W
5	0.9	10	0.8
10	1.28	20	0.98
15	1.62	40	1.60
20	1.82	60	1.82
25	1.99	80	2.00
30	2.12	100	2.05
40	2.36	120	2.13
60	2.84	140	2.44
80	3.68	160	2.80
100	200	200	100

$S1, S2$ = inflection points
 KI = curve I
 KII = curve II

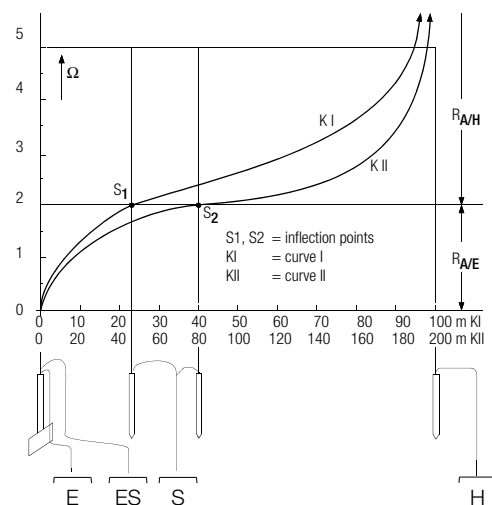
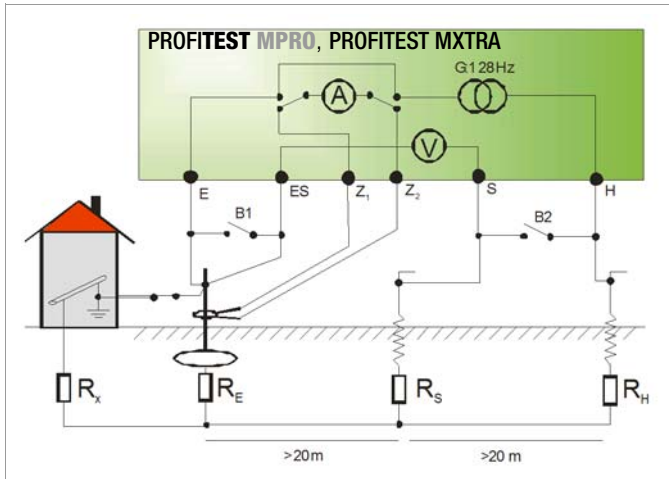

Figure 10.8.4: Earthing Resistance Measurement for a Large Scope Earthing System

10.9 Earthing Resistance Measurement, Battery Operated – Selective (4-pole) with Current Clamp Sensor and PRO-RE Measuring Adapter as Accessory (only MPRO & MXTRA)

General



When measuring earthing resistance in systems with several parallel connected earth electrodes, total resistance of the earthing system is measured.

Two earth spikes (auxiliary earth electrode and probe) are set for this measurement. Measuring current is fed between the earth electrode and the auxiliary earth electrode and voltage drop is measured between the earth electrode and the probe.

The current clamp is positioned around the earth electrode to be measured, and thus only that portion of the measuring current which flows through the earth electrode is measured.

Connection

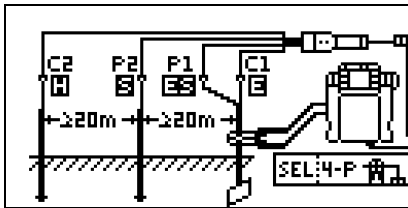

- ◇ Position the spikes for the probe and the auxiliary electrode at least 20, respectively 40 meters from the electrode (see figure above).
- ◇ Make sure that no excessively high contact resistances occur between the probe and the ground.
- ◇ Attach the **PRO-RE adapter (Z501S)** to the test plug.
- ◇ Connect the probes, the auxiliary electrode and the electrode via the 4 mm banana plug sockets at the **PRO-RE adapter**. In doing so, observe labeling on the banana plug sockets.
- ◇ Connect the **Z3512A current clamp sensor** to jacks 15 and 16 at the test instrument.
- ◇ Attach the current clamp sensor to the earth electrode.

Select Measuring Function



Select Operating Mode



The selected operating mode is displayed inversely: white battery icon against black background.

Set Parameters at Tester

- Measuring range: 200 Ω



Note

After switching to selective measurement, the AUTO measuring range is activated automatically if a measuring range of greater than 200 Ω had been selected.

- Connection type: selective
- Current clamp sensor transformer ratio:
1:1 (1 V/A), 1:10 (100 mV/A), 1:100 (10 mV/A)
- Distance d (for measuring ρ_E): irrelevant in this case

Set Parameters at Current Clamp Sensor

- Current clamp sensor measuring range: see table below

Selecting a Measuring Range at the Current Clamp Sensor

Tester	Z3512A Clamp	
Transformation Ratio Parameter	Switch	Measuring Range
1:1 1 V / A	1 A / x 1	1 A
1:10 100 mV / A	10 A / x 10	10 A
1:100 10 mV / A	100 A / x 100	100 A

Important Instructions for Use of the Current Clamp Sensor

- Use only the Z3512A current clamp sensor for this measurement.
- Use the clamp in the permanently connected state. The sensor may not be moved during measurement.
- The current clamp sensor may only be used at an adequate distance from **powerful extraneous fields**.
- Make sure that the current clamp sensor's connector cable is laid separate from the probe cables to the greatest possible extent.

Start Measurement

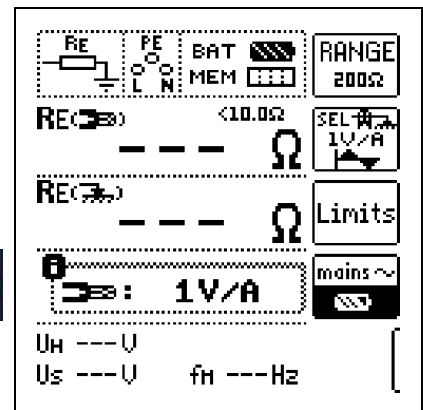

10.10 Earthing Resistance Measurement, Battery Powered – Ground Loop Measurement (with current clamp sensor and transformer, plus PRO-RE/2 measuring adapter as accessory) (only MPRO & MXTRA)

2-Clamp Measuring Method

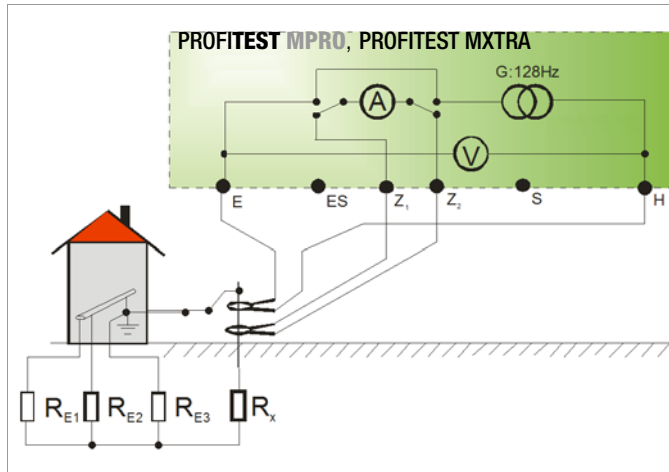

In the case of earthing systems which consist of several earth electrodes ($R_1 \dots R_x$) which are connected to each other, earthing resistance of a single electrode (R_x) can be ascertained with the help of 2 current clamps without disconnecting R_x or using spikes.

This measuring method is especially well suited for buildings or systems for which probes and auxiliary earth electrodes cannot be used, or where it's impermissible to disconnect earth electrodes.

Furthermore, this "spike-free" measurement is performed as one of three measurements for lightning protection systems, in order to determine whether or not current can be dissipated.

Figure at right:
PRO-RE/2 measuring adapter as accessory for connecting the E-Clip 2 generator current clamp

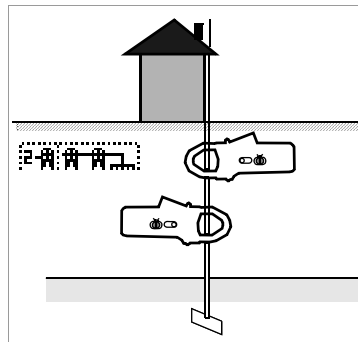

Connection

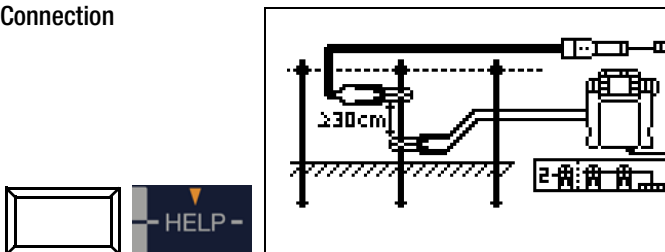

- ⊘ No probes or auxiliary earth electrodes are required.
- ⊘ The earth electrode is not disconnected.
- ⊘ Attach the **PRO-RE/2 adapter (Z502T)** to the test plug.
- ⊘ Connect the **E-Clip 2 generator clamp (current clamp transformer)** via the 4 mm safety plugs at the PRO-RE/2 adapter.
- ⊘ Connect the **Z3512A current clamp sensor** to jacks 15 and 16 at the test instrument.
- ⊘ Attach the 2 clamps to an earth electrode (earth spike) at different heights with a clearance of at least 30 cm.

Select Measuring Function



Select Operating Mode



The selected operating mode is displayed inversely: white battery icon against black background.

Set Parameters at Tester

- ⊘ **Measuring range:** in this case always AUTO



Note

After selecting to 2-clamp measurement, switching to the AUTO range takes place automatically. It is then no longer possible to change the range!

- ⊘ **Connection type:** 2-clamp
- ⊘ **Current clamp sensor transformer ratio:**
1:1 (1 V/A), 1:10 (100 mV/A), 1:100 (10 mV/A)
- ⊘ **Distance d (for measuring ρ_{E}):** irrelevant in this case

Set Parameters at Current Clamp Sensor

- ⊘ **Current clamp sensor measuring range:** see table below

Selecting a Measuring Range at the Current Clamp Sensor

Tester	Z3512A Clamp	
Transformation Ratio Parameter	Switch	Measuring Range
1:1 1 V / A	1 A / x 1	1 A
1:10 100 mV / A	10 A / x 10	10 A
1:100 10 mV / A	100 A / x 100	100 A

Important Instructions for Use of the Current Clamp Sensor

- Use only the Z3512A current clamp sensor for this measurement.
- Use the **clamp in the permanently connected state**. The sensor may not be moved during measurement.
- The current clamp sensor may only be used at an adequate distance from **powerful extraneous fields**.
- Make sure that the connector cables from the two clamps are laid separate from each other to the greatest possible extent.

Start Measurement

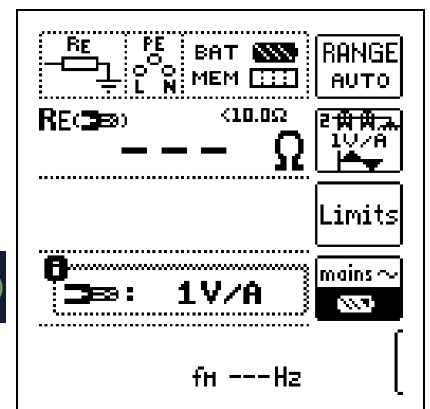
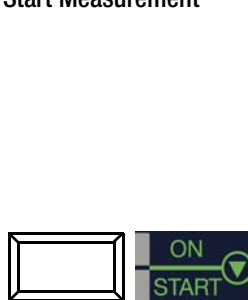

10.11 Earthing Resistance Measurement, Battery Powered – Measurement of Soil Resistivity ρ_E (only MPRO & MXTRA)

General

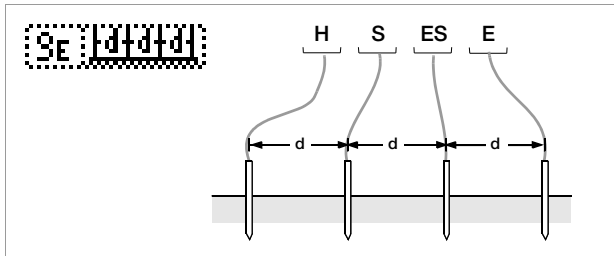

Measurement of Soil Resistivity

The determination of soil resistivity is necessary for the planning of earthing systems. Reliable values need to be ascertained which take even the worst possible conditions into account (see “Geologic Evaluation” on page 43).

Soil resistivity is decisive with regard to the magnitude of an earth electrode's dissipation resistance. Soil resistivity can be measured with the **PROFITEST MASTER** using the method according to Wenner.

Four earth spikes of greatest possible length are driven into the ground in a straight line at distance d from one another, and are connected to the earth tester (see figure above). The earth spikes usually have a length of 30 to 50 cm. Longer earth spikes can be used for soil which demonstrates poor conductivity (sandy soil etc.). The depth to which the earth spikes are driven into the ground may not exceed one twentieth of distance d .

Note

Erroneous measurement may result in the event that piping, cables or other underground metal conduits run parallel to the measuring setup.

Soil resistivity is calculated as follows:

$$\rho_E = 2\pi \cdot d \cdot R$$

Where:

$$\pi = 3.1416$$

d = distance in m between two earth spikes

R = ascertained resistance value in Ω (this value corresponds to R_E as determined with the 4-wire method)

Connection

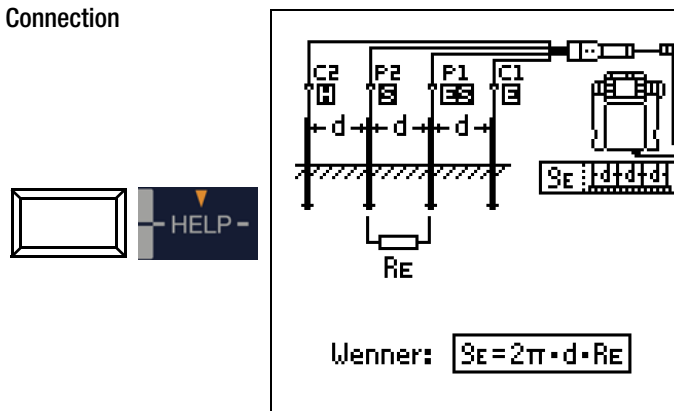

- Position the spikes for the probe and the auxiliary electrode at equal distances (see figure above).
- Make sure that no excessively high contact resistances occur between the probe and the ground.
- Attach the **PRO-RE adapter (Z501S)** to the test plug.
- Connect the probes, the auxiliary electrode and the electrode via the 4 mm banana plug sockets at the PRO-RE adapter. In doing so, observe labeling on the banana plug sockets.

Select Measuring Function



Select Operating Mode



The selected operating mode is displayed inversely: white battery icon against black background.

Set Parameters

- Measuring range: AUTO, 50 k Ω , 20 k Ω , 2 k Ω , 200 Ω , 20 Ω
- Connection type: ρ_E (Rho)
- Transformer ratio: irrelevant in this case
- Distance d for measurement of ρ_E : adjustable from 0.1 to 999 m

Start Measurement

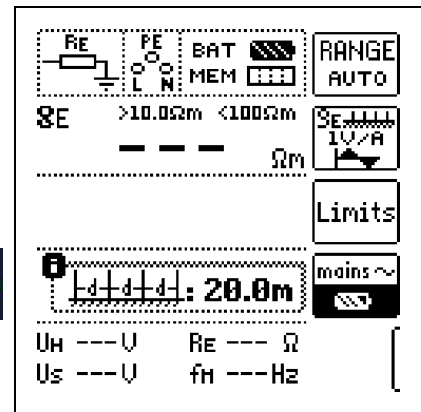

Geologic Evaluation

Except in extreme cases, the ground is measured down to a depth which is roughly equal to probe distance d . This makes it possible to arrive at conclusions regarding the ground's stratification by varying probe distance. Layers which are highly conductive (water table), into which earth electrodes should be installed, can thus be discovered within a region which is otherwise poorly conducting.

Soil resistivity is subject to considerable fluctuation which may be due to various causes such as porosity, moisture penetration, concentration of dissolved salts in the ground water and climatic fluctuation.

Characteristic values for ρ_E relative to season (soil temperature and the soil's negative temperature coefficient) can be approximated quite closely by means of a sinusoidal curve.

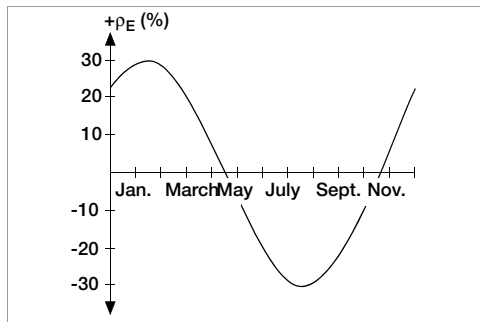

Soil Resistivity ρ_E Relative to Season Without the Effects of Precipitation (earth electrode depth < 1.5 m)

A number of typical soil resistivity values for various types of ground are summarized in the following table.

Type of Soil	Soil Resistivity ρ_E [Ωm]
Marshy ground	8 ... 60
Arable soil, loamy and clayey soil, moist gravel	20 ... 300
Moist sandy soil	200 ... 600
Dry sandy soil, dry gravel	200 ... 2000
Rocky ground	300 ... 8000
Rock	10^4 ... 10^{10}

Soil Resistivity ρ_E with Different Types of Soil

Calculating Dissipation Resistance

Formulas for calculating dissipation resistance for common types of earth electrodes are included in this table. These rules of thumb are entirely adequate for actual practice.

Number	Earth Electrode	Rule of Thumb	Subsidiary Variable
1	Earth strip (star type earth electrode)	$R_A = \frac{2 \cdot \rho_E}{l}$	—
2	Earth rod (buried earth electrode)	$R_A = \frac{\rho_E}{l}$	—
3	Ring earth electrode	$R_A = \frac{2 \cdot \rho_E}{3D}$	$D = 1,13 \cdot \sqrt[2]{F}$
4	Mesh earth electrode	$R_A = \frac{2 \cdot \rho_E}{2D}$	$D = 1,13 \cdot \sqrt[2]{F}$
5	Ground plate	$R_A = \frac{2 \cdot \rho_E}{4,5 \cdot a}$	—
6	Hemispherical earth electrode	$R_A = \frac{\rho_E}{\pi \cdot D}$	$D = 1,57 \cdot \sqrt[3]{J}$

Formulas for Calculating Dissipation Resistance R_A for Various Earth Electrodes

R_A = dissipation resistance (Ω)

ρ_E = soil resistivity (Ωm)

l = length of the earth electrode (m)

D = diameter of a ring earth electrode, diameter of the equivalent surface area of a mesh earth electrode or diameter of a hemispherical earth electrode (m)

F = surface area (sq. meters) of the enclosed surface or a ring or mesh earth electrode

a = Edge length (m) of a square ground plate; a is replaced with the following for rectangular plates: $\sqrt{b \times c}$, where b and c are the two sides of the rectangle.

J = volume (cubic meters) of an individual foundation footing

11 Measuring Insulation Resistance



Attention!

Insulation resistance can only be measured at voltage-free objects.

11.1 General

Select Measuring Function



Connection

2 pole adapter or test plug

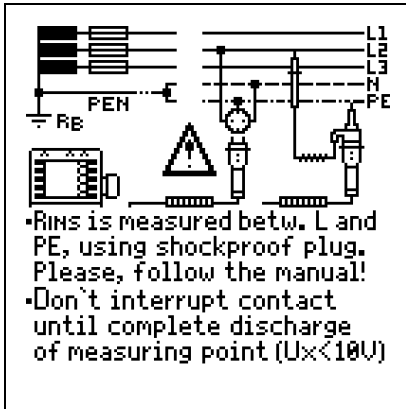

Note

The test instrument measures the insulation between the contacts L and PE. In systems without RCD, N and PE must be separated.



Note

Checking Measurement Cables Before Measurements

Before performing insulation measurement, the test probes on the measurement cables should be short-circuited in order to assure that the instrument displays a value of less than 1 kΩ. In this way, incorrect connection can be avoided and broken measurement cables can be detected.

Set Parameters

Test voltage: 50 V / 100 V / 250 V / 325 V / 500 V / 1000 V xxx V*

Voltage type: constant

Voltage type: rising/ramp

Earth leakage resistance:

* Freely adjustable voltage (see section 5.7)

Polarity Selection

2-pole meas. (relevant for report generating only):

Measurements between Lx-PE / N-PE / L+N-PE / Lx-N / Lx-Ly / AUTO* where x, y = 1, 2, 3

* AUTO parameter (see section 5.8)

Breakdown current for Ramp Function

I_{LIM} 1.00mA

U_{INS} Limit value: I: 1.00mA

$I > I_{Limit}$ STOP

Limit values for Breakdown Voltage

Limits

U_{INS} low limit: U: >250V upper limit: U: <750V

input range: > 40 V ... < 999 V

Limit Values for Constant Test Voltage

Limits

U_{INS} Limit value: R: >1.0MΩ

$R_{INS} < Limit Value$

Test voltage

A test voltage which deviates from nominal voltage, and is usually lower, can be selected for measurements at sensitive components, as well as systems with voltage limiting devices.

Voltage Type

The " U_{INS} " rising test voltage function (ramp function) is used to detect weak points in the insulation, as well as to determine response voltage for voltage limiting components. After briefly pressing the ON/START key, test voltage is continuously increased until specified nominal voltage U_N is reached. U is the voltage which is measured at the test probes during and after testing. This voltage drops to a value of less than 10 V after measurement (see section entitled "Discharging the Device Under Test").

Insulation measurement with rising test voltage is ended:

- As soon as specified maximum test voltage U_N is reached and the measured value is stable
- or
- As soon as specified maximum test voltage is reached, e.g. after sparkover occurs at breakdown voltage).

Specified maximum test voltage U_N or any occurring triggering or breakdown voltage is displayed for U_{INS} .

The constant test voltage function offers two options:

- After briefly pressing the ON/START key, specified test voltage U_N is read out and insulation resistance R_{INS} is measured. As soon as the measured value is stable (settling time may be several seconds in the case of high cable capacitance values), measurement is ended and the last measured values for R_{INS} and U_{INS} are displayed. U is the voltage which is measured at the test probes during and after testing. This voltage drops to a value of less than 10 V after measurement (see section entitled "Discharging the Device Under Test").

or

- **As long as** you press and hold the ON/START key, test voltage U_N is applied and insulation resistance R_{INS} is measured. Do not release the key until the measured value has settled in (settling time may be several seconds in the case of high cable capacitance values). Voltage U , which is measured during testing, corresponds to voltage U_{INS} . After releasing the ON/START key, measurement is ended and the last measured values for R_{INS} and U_{INS} are displayed. U drops to a value of less than 10 V after measurement (see section entitled “Discharging the Device Under Test”).

□ Pole Selection Report Entry

The poles between which testing takes place can only be entered here for reporting purposes. The entry itself has no influence on the actual polarity of the test probes or pole selection.

□ Limits – Setting the Limit Value

The limit value for insulation resistance can be set as desired. If measurement values occur which are below this limit value, the red U_L/R_L LED lights up. A selection of limit values ranging from 0.5 to 10 M Ω is available. The limit value is displayed above the measured value.

Start Measurement – Rising Test Voltage (ramp function)

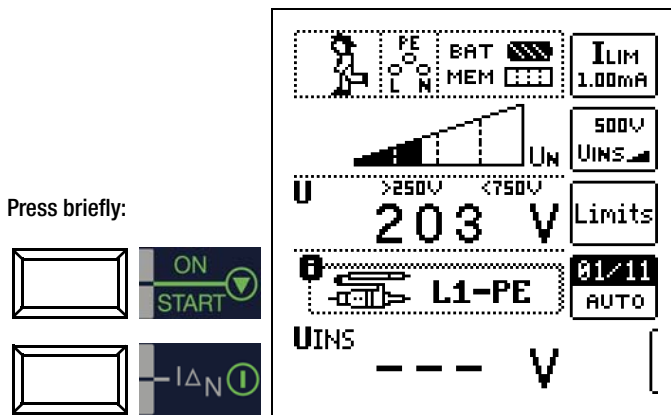

Quick polarity reversal if parameter is set to AUTO: 01/10 ... 10/10: L1-PE ... L1-L3

Note

If “semiautomatic polarity reversal” is selected (see section 5.8), the corresponding icon is displayed instead of the ramp.

General Notes Regarding Insulation Measurements with Ramp Function

Insulation measurement with ramp function serves the following purposes:

- Detect weak points in the test object’s insulation
- Determine tripping voltage of voltage limiting components and test them for correct functioning. These components may include, for example, varistors, overvoltage limiters (e.g. DEHNguard® from Dehn+Söhne) and spark gaps.

The test instrument uses continuously rising test voltage for this measuring function, up to the maximum selected voltage limit. The measuring procedure is started by pressing the START/STOPP key and runs automatically until one of the following events occurs:

- The selected voltage limit is reached
- The selected current limit is reached
- Sparkover occurs (spark gaps)

Differentiation is made amongst the following three procedures for insulation measurement with ramp function:

Testing of overvoltage limiters or varistors and determining their tripping voltage:

- Select maximum voltage such that the anticipated breakdown voltage of the device under test is roughly one third of this value (observe manufacturer’s data sheet if applicable).
- Select current limit value in accordance with actual requirements or the manufacturer’s data sheet (characteristic curve of the device under test).

Determining tripping voltage for spark gaps:

- Select maximum voltage such that the anticipated breakdown voltage of the device under test is roughly one third of this value (observe manufacturer’s data sheet if applicable).
- Select the current limit value in accordance with actual requirements within a range of 5 to 10 μ A (response characteristics are too unstable with larger current limit values, which may result in faulty measurement results).

Detecting weak points in the insulation:

- Select maximum voltage such that it does not exceed the test object’s permissible insulation voltage; it can be assumed that an insulation fault will occur even with a significantly lower voltage if an accordingly lower maximum voltage value is selected (nevertheless at least greater than anticipated breakdown voltage) – the ramp is less steep as a result (increased measuring accuracy).
- Select the limit current value in accordance with actual requirements within a range of 5 to 10 μ A (see also settings for spark gaps).

Start Measurement – Constant Test Voltage

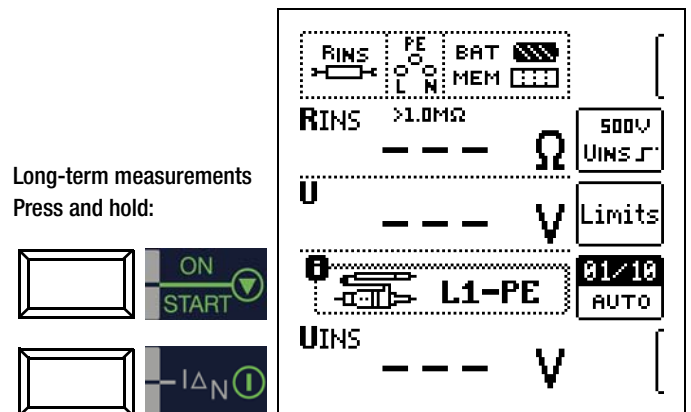

Quick polarity reversal if parameter is set to AUTO: 01/10 ... 10/10: L1-PE ... L1-L3

Note

The instrument’s batteries are rapidly depleted during the insulation resistance measurement. When using the “constant test voltage” function, only press and hold the Start \blacktriangledown key until the display has become stable (if long-term measurement is required).

Special Condition for Insulation Resistance Measurement

! Attention!

Insulation resistance can only be measured at voltage-free objects.

If measured insulation resistance is less than the selected limit value, the U_L/R_L LED lights up.

If an interference voltage of ≥ 25 V is present within the system, insulation resistance is not measured. The MAINS/NETZ LED lights up and the “interference voltage” pop-up message appears. All conductors (L1, L2, L3 and N) must be tested against PE!

Attention!

Do not touch the instrument's terminal contacts during insulation resistance measurements!

If nothing has been connected to the terminal contacts, or if a resistive load component has been connected for measurement, your body would be exposed to a current of approx. 1 mA at a voltage of 1000 V. The noticeable shock may lead to injury (e.g. resulting from a startled reaction etc.).

Discharging the Device Under Test

Attention!

If measurement is performed at a capacitive object such as a long cable, it becomes charged with up to approx. 1000 V!
Touching such objects is life endangering!

When an insulation resistance measurement has been performed on a capacitive object it is automatically discharged by the instrument after measurement has been completed. Contact to the device under test must be maintained to this end. The falling voltage value can be observed at the U display.

Do not disconnect the DUT until less than 10 V is displayed for U!

Evaluation of Measured Values

Instrument measuring error must be taken into consideration in order to assure that the limit values set forth in DIN VDE regulations are not fallen short of. The required minimum display values for insulation resistance can be determined with the help of Table 3 on page 88. These values take maximum device error into consideration (under nominal conditions of use). Intermediate values can be interpolated.

11.2 Special Case: Earth Leakage Resistance (R_{EISO})

This measurement is performed in order to determine electrostatic discharge capacity for floor coverings in accordance with EN 1081.

Select Measuring Function



Set Parameters

* Freely adjustable voltage (see section 5.7)

Connection and Test Set-Up



- Rub the floor covering at the point at which measurement is to be performed with a dry cloth.
- Place the 1081 floor probe onto the point of measurement and load it with a weight of at least 300 N (30 kg).
- Establish a conductive connection between the measuring electrode and the Test Probe and connect the measuring adapter (2-pole) to an earth contact, e.g. the earthing contact at a mains outlet or a central heating radiator (prerequisite: reliable ground connection).

Start Measurement



The limit value for earth leakage resistance from the relevant regulations applies.

12 Measuring Low-Value Resistance up to 200 Ohm (protective conductor and equipotential bonding conductor)

According to the regulations, the measurement of low-value resistance at protective conductors, earth conductors or bonding conductors must be performed with (automatic) polarity reversal of the test voltage, or with current flow in one (+ pole to PE) and then the other direction (- pole to PE).



Attention!

Low-value resistance must only be measured at voltage-free objects.

Select Measuring Function

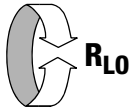

Connection

Via 2-pole adapter only!

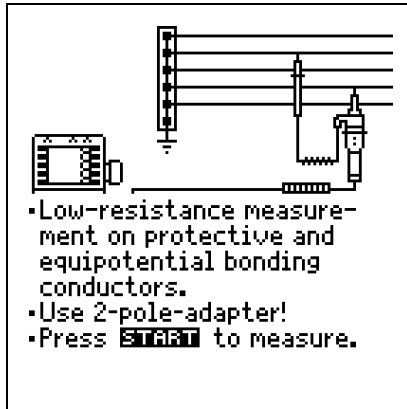

Set Parameters

ROFFSET ON OFF ROFFSET: ON ↔ OFF

TYP \rightarrow PE Polarity: +/- to PE

Polarity: +/- to PE with ramp function

Limits Limit value: $R_{LO} < 1.00 \Omega$

$R_{LO} > \text{Limit Value}$

$U_L | R_L$

ROFFSET ON/OFF

– Compensation for Extension Cables with up to 10 Ω

If measurement cables or extension cables are used, their resistance can be deducted automatically from the measurement results. Proceed as follows:

- Switch **ROFFSET** from OFF to ON. “**ROFFSET = 0.00 Ω** ” appears in the footer.
- Select a polarity option or automatic polarity reversal.
- Short-circuit the end of the measurement extension cable with the second test probe at the instrument.
- Start measurement of offset resistance with $I_{\Delta N}$.

An intermittent acoustic signal sounds first, which is then accompanied by a blinking warning to prevent an offset value which has already been saved from being unintentionally deleted.

- Start the offset measurement by pressing the release key again or abort measurement by pressing the key **ON/START** (here = ESC).



Note

If the offset measurement is stopped by an error pop-up ($R_{offset} > 10 \Omega$ or difference between R_{LO+} and R_{LO-} greater than 10%), the offset value that has last been measured is retained. Inadvertent deletion of an offset value once established is thus almost ruled out! The respectively smaller value is otherwise stored to memory as an offset value. The maximum offset value is 10.0 Ω . Negative resistances may result due to the offset value.

Measuring ROFFSET

RLO $< 1.00 \Omega$ \rightarrow PE

0.00 Ω

Limits

ROFFSET ON OFF

ROFFSET 0.43 Ω

The **ROFFSET** x.xx Ω message now appears in the footer at the display, where x.xx may take a value between 0.00 and 10.0 Ω . This value is subtracted from the actual measuring results for all subsequent R_{LO} measurements, if the **ROFFSET ON/OFF** key has been set to ON.

ROffset must be determined anew in the following cases:

- After switching to a different polarity option
- After switching from ON to OFF and back again

You can deliberately delete the offset value by switching **ROFFSET** from OFF to ON.



Note

Only use this function when performing measurements with extension cables. When different extension cables are used, the above described procedure must always be repeated.

Type / Polarity

The direction in which current flows can be selected here.

Limits – Setting the Limit Value

The limit value for resistance can be set as desired. If measurement values which exceed this limit occur, the red U_L/R_L LED lights up. Limit values can be selected between 0.10 Ω and 10.0 Ω (editable). The limit value is displayed above the measured value.

12.1 Measurements with Constant Test Current

Start Measurement



Press and hold for long-term measurement

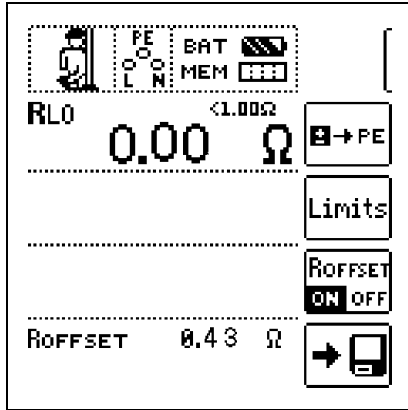

Attention!

The test probes should always be in contact with the DUT before pressing the Start ▼ key.

If the object is energized, measurement is disabled as soon as it is contacted with the test probes.

If the Start ▼ key is pressed first and the test object is contacted with the test probes afterwards, the fuse blows.

Which of the two fuses has blown is indicated in the pop-up window with the error message by means of an arrow.

In the case of single-pole measurement, the respective value is saved to the database as RLO.

Polarity Selection	Display	Condition
+ pole to PE	RLO+	None
- pole to PE	RLO-	None
± pole to PE	RLO	If $\Delta RLO \leq 10\%$
	RLO+ RLO-	If $\Delta RLO > 10\%$

Automatic Polarity Reversal

After the measuring sequence has been started, the instrument performs measurement with automatic polarity reversal, first with current flow in one direction, and then in the other. In the case of long-term measurement (press and hold START key), polarity is switched once per second.

If the difference between RLO+ and RLO- is greater than 10% with automatic polarity reversal, RLO+ and RLO- values are displayed instead of RLO. The respectively larger value, RLO+ or RLO-, appears at the top and is saved to the database as the RLO value.

Evaluating Measurement Results

Differing results for measurements in both directions indicate voltage at the DUT (e.g. thermovoltages or unit voltages).

Measurement results can be distorted by parallel connected impedances at load current circuits and by equalizing current, especially in systems which make use of "overcurrent protection devices" (previous neutralization) without an isolated protective conductor. Resistances which change during measurement (e.g. inductance), or a defective contact, can also cause distorted measurements (double display).

In order to assure unambiguous measurement results, causes of error must be located and eliminated.

In order to find the cause of the measuring error, measure resistance in both current flow directions.

The instrument's batteries are exposed to excessive stress during insulation resistance measurement. For measurement with current flow in one direction, only press and hold the **START ▼** key as long as is necessary for the measurement.



Note

Measuring Low-Value Resistance
Measurement cable and 2-pole measuring adapter resistance is compensated for automatically thanks to the four conductor method and thus do not effect measurement results. However, if an extension cable is used its resistance must be measured and deducted from the measurement results.

Resistances which do not demonstrate a stable value until after a "settling in period" should not be measured with automatic polarity reversal, but rather one after the other with positive and negative polarity.

Examples of resistances whose values may change during measurement include:

- Incandescent lamp resistance, whose values change due to warming caused by test current
- Resistances with a great conductive component
- Contact resistance

Evaluation of Measured Values

See Table 4 on page 88.

Calculation of Cable Lengths for Common Copper Conductors

If the HELP key is activated after performing resistance measurement, the cable lengths corresponding to common conductor cross sections are displayed.



RLO: 0.16 Ω			
Ø	l	Ø	l
[mm²]	[m]	[mm²]	[m]
0.14:	1	2.5:	20
0.25:	2	4.0:	32
0.50:	4	6.0:	48
0.75:	6	10.0:	80
1.00:	8	16.0:	127
1.50:	12	25.0:	199

If results vary for the two different current flow directions, cable length is not displayed. In this case, capacitive or inductive components are apparently present which would distort the calculation.

This table only applies to cables made with commercially available copper conductors and cannot be used for other materials (e.g. aluminum)!

12.2 Protective Conductor Resistance Measurement with Ramp Curve – Measurements on PRCDs with Current-monitored Protective Conductor Using PROFITEST PRCD Test Adapter as Accessory

Application

In certain PRCD types, the protective conductor current is monitored. Direct application or disconnection of the test current of 200 mA, which is required for protective conductor resistance measurements, results in tripping of the PRCD and, consequently, a cut-off of the protective conductor connection. Protective conductor measurement is no longer possible in this case.

A special ramp curve for the application or disconnection of the test current in combination with the PROFITEST PRCD test adapter allows for performing protective conductor resistance measurements without PRCDs being tripped.

Timed Sequence of the Ramp Function

Due to the physical properties of the PRCD, the **measuring cycles** of this ramp function lie within the range of several seconds.

Moreover, while the polarity of the test current is being reversed, an additional **waiting period** during polarity reversal becomes necessary.

This waiting period has been included in the test sequence in operating mode „automatic polarity reversal“ .

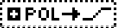
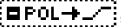
If you change the polarity direction manually, e.g. from „+pole with ramp“  to „-pole with ramp“ , the test instrument recognizes the change in the current flow direction, disables measurements for the required waiting period and simultaneously shows the respective symbol, see figure on the right.

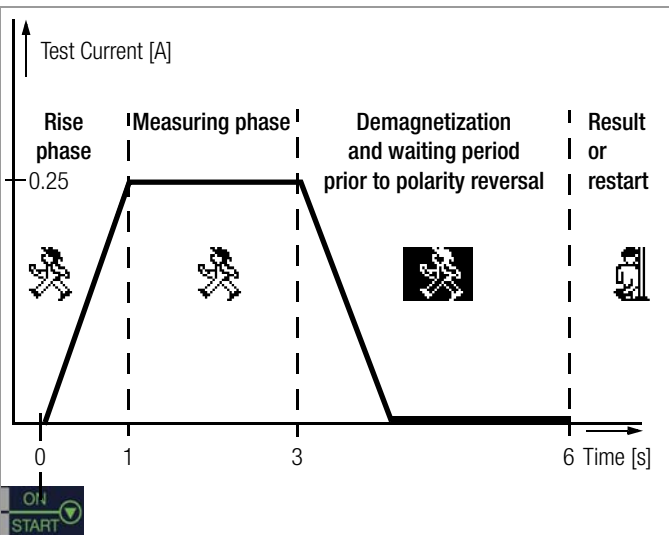
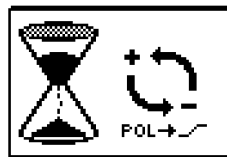

Visualization of the measuring and waiting phases during protective conductor resistance measurements on PRCDs with the PROFITEST MXTRA

Tripping of a PRCD due to faulty contact

During measurement, safe contact between the test probes of the 2-pole adapter and the DUT or the sockets of the PROFITEST PRCD test adapter is to be ensured. Interruptions may lead to heavy fluctuations in the test current which may cause the PRCD to trip in the worst case.

In this event, the tripping of the PRCD is automatically recognized by the test instrument as well and an error message is generated, see figure on the right. In this case as well, the test instrument automatically takes into account the required waiting period before re-enabling the PRCD and allowing any new measurements.

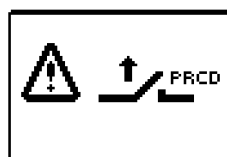

Connection

- Please consult the operating instructions of the PROFITEST PRCD adapter, particularly chapter 4.1. There you will also find information on the connection terminals for offset measurements and protective conductor resistance measurements.

Selecting Polarity Parameter

- Select the requested polarity parameter with ramp.



Measuring ROFFSET

- Perform an offset measurement as described on page 47, to assure that the test adapter's connector contacts are not included in the measurement results.



Note

The offset only remains saved to memory until you change the polarity parameter. If you perform the measurement with manual polarity reversal (+pole or -pole), you have to repeat the offset measurement before each measurement with another polarity.

Measuring Protective Conductor Resistance

- Check whether the PRCD is activated. If this is not the case, activate it.
- Perform the protective conductor measurement as described above in section 12.1. Start the test sequence by briefly pressing key ON/START. By pressing and holding key ON/START you can extend the preset duration of the measuring phase.

Start measurement

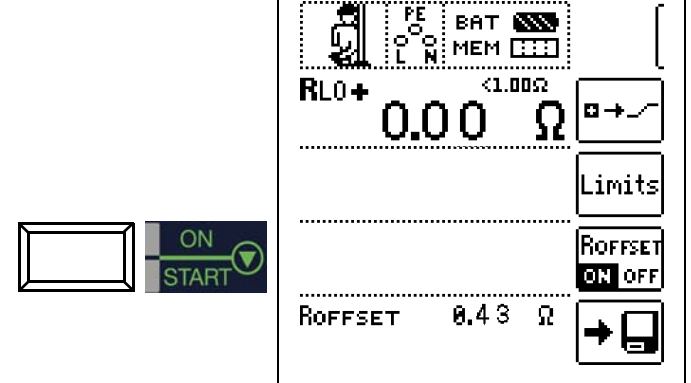

During the magnetization phase (rising curve) and the subsequent measuring phase (constant current) the symbol on the right is shown. 

If you abort the measurement during the rise phase, no measuring result can be issued and displayed.

After the measurement, the demagnetization phase (declining curve) and a subsequent waiting period is signalled with the inverse symbol shown on the right.  During this period, no new measurements are possible.

Only when the symbol on the right is shown, can the measurement result be read and measurements started with the same or another polarity. 

13 Measurement with Accessory Sensors

13.1 Current Measurement with Current Clamp Sensor

Bias, leakage and circulating current to 1 A, as well as leakage current to 1000 A can be measured with the help of special current clamp sensors, which are connected to sockets 15 and 16.

Attention!

Danger: High-Voltage!

Use only current clamp sensors which are specifically offered as accessories by GMC-I Messtechnik GmbH. Other current clamp sensors might not be terminated with an output load at the secondary side. Dangerously high voltage may endanger the user and the device in such cases.

Attention!

Maximum input voltage at the test instrument!

Do not measure any currents which are greater than specified for the measuring range of the respective clamp. Input voltage for clamp connector sockets 15 and 16 at the test instrument may not exceed 1 V!

Attention!

Be sure to read and adhere to the **operating instructions** for current clamp sensors and the safety precautions included therein, especially those regarding the approved measuring category.

Select Measuring Function

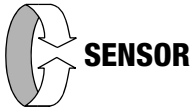

Selecting a Measuring Range at the Current Clamp Sensor

Tester Transformation Ratio Parameter	Clamp				Tester Measuring Range
	Switch WZ12C	Switch Z3512A	Measuring Range WZ12C	Measuring Range Z3512A	
1:1 1 V / A	1 mV / mA	x 1000 [mV/A]	1 mA ... 15 A	0 ... 1 A	5 ... 999 mA
1:10 100 mV / A	—	x 100 [mV/A]	—	0 ... 10 A	0.05 ... 10 A
1:100 10 mV / A	—	x 10 [mV/A]	—	0 ... 100 A	0.5 ... 100 A
1:1000 1 mV / A	1 mV / A	x 1 [mV/A]	1 A ... 150 A	0 ... 1000 A	5 ... 150 A / 999 A

Tester Transformation Ratio Parameter	Clamp		Tester Measuring Range
	Switch METRAFLEX P300	Measuring Range METRAFLEX P300	
1:1 1 V / A	3 A (1 V/A)	3 A	5 ... 999 mA
1:10 100 mV / A	30 A (100 mV/A)	30 A	0.05 ... 10 A
1:100 10 mV / A	300 A (10 mV/A)	300 A	0.5 ... 100 A

Set Parameters

The transformation ratio parameter must be correspondingly set at the test instrument depending upon the respectively selected measuring range at the current clamp sensor.

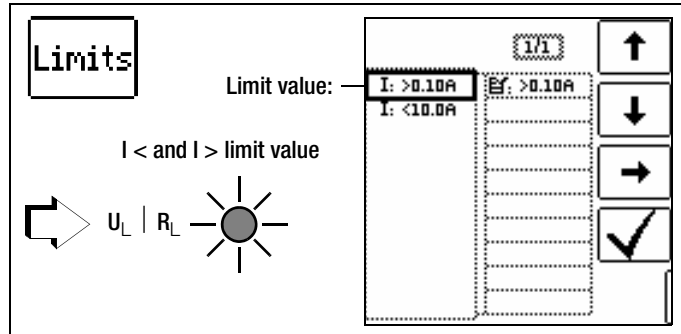
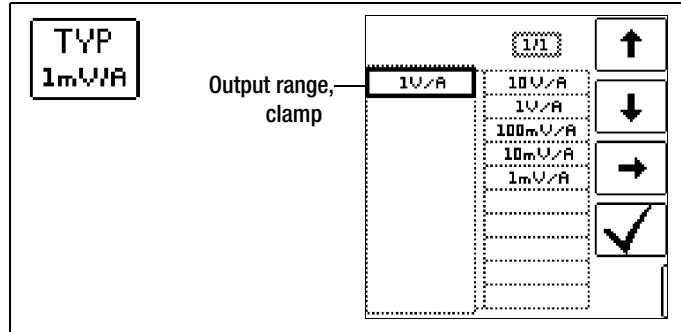

Specifying limit values results in automatic evaluation at the end of the measurement.

Connection

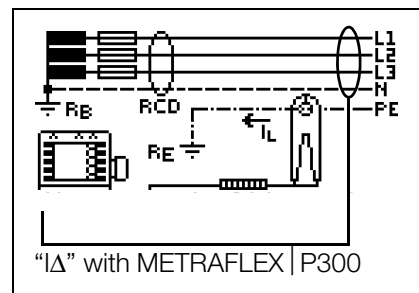
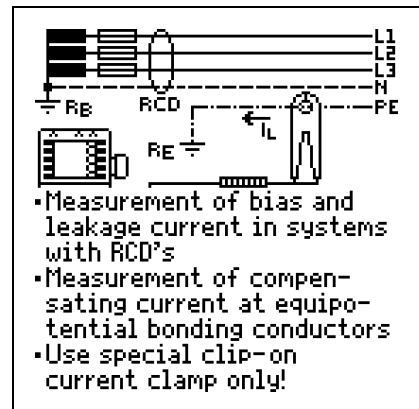

Start Measurement

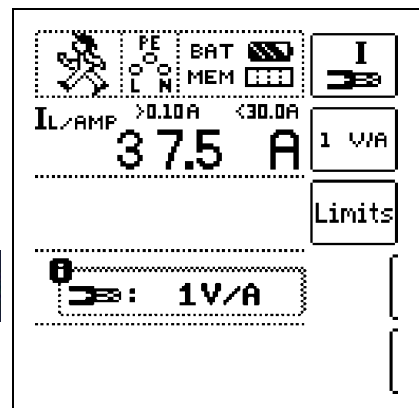

14 Special Functions – EXTRA Switch Position

Select EXTRA Switch Position

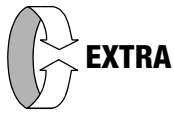

Overview of Special Functions

Softkey	Meaning / Special Function	Mbase+	MTECH+	MPRO	MXTRA	SECULIFE IP	Section / Page
	Voltage drop measurement ΔU function	✓	✓	✓	✓	✓	section 14.1 page 52
	Standing surface insulation impedance Z _{ST} function	✓	✓	✓	✓	✓	section 14.2 page 53
	Meter start-up test kWh function	✓	✓	✓	✓	—	section 14.3 page 54
	Leakage Current Measurement I _L function	—	—	—	✓	✓	section 14.4 page 55
	Check insulation monitoring device IMD function	—	—	—	✓	✓	section 14.5 page 56
	Residual voltage test Ures function	—	—	—	✓	—	section 14.6 page 58
	Intelligent ramp ta + IΔ function	—	—	—	✓	—	section 14.7 page 59
	Residual current monitor (RCM) RCM function	—	—	—	✓	—	section 14.8 page 60
	Testing the operating states of electric vehicles at charging stations per IEC 61851	—	✓	—	✓	—	section 14.9 page 61
	Report generation of fault simulations on PRCDs with PROFITEST PRCD adapter	—	—	—	✓	—	section 14.10 page 62

Selecting Special Functions

The list of special functions is accessed by pressing the uppermost softkey. Select the desired function with the requested icon.

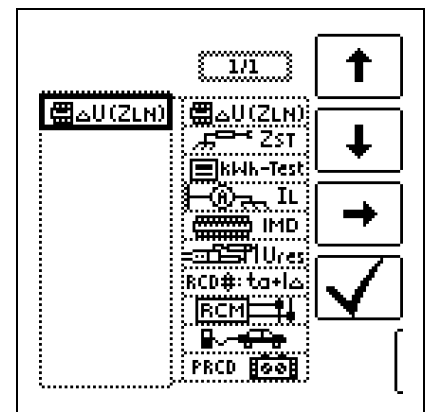
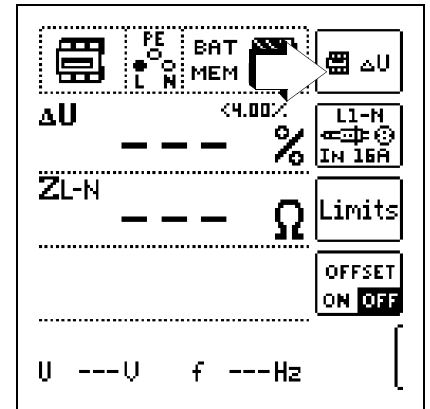

14.1 Voltage Drop Measurement (at Z_{L-N}) – ΔU Function

Significance and Display of ΔU (per DIN VDE 100, part 600)

Voltage drop from the intersection of the distribution network and the consumer system to the point of connection of an electrical power consumer (electrical outlet or device connector terminals) should not exceed 4% of nominal line voltage.

Calculating voltage drop (without offset):

$$\Delta U = Z_{L-N} \cdot \text{nominal current of the fuse}$$

Calculating voltage drop (with offset):

$$\Delta U = (Z_{L-N} - Z_{\text{OFFSET}}) \cdot \text{nominal current of the fuse}$$

$$\Delta U \text{ in } \% = 100 \cdot \Delta U / U_{L-N}$$

See also section 9 regarding measurement procedure and connection.

Connection and Test Set-Up

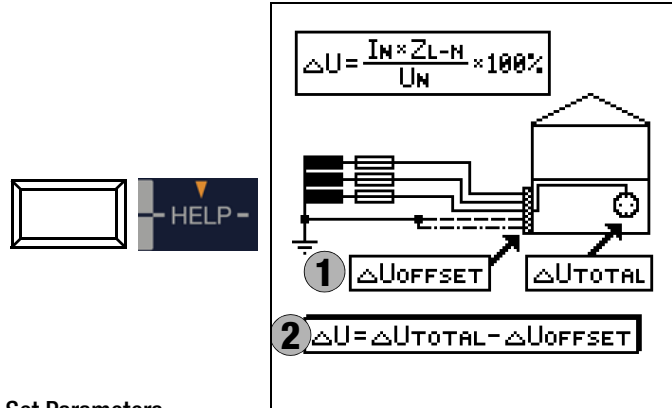

Set Parameters

L1-N
IN 16A

Polarity selection: Lx-N

Nominal current of the fuse: 2 to 160 A

Tripping characteristics: B, L

Diameter: 1.5 to 70 sq. mm

Cable types: NY..., H03... - H07...

Number of wires: 2 ... 10-strand

Note: When the nominal current I_N is changed with existing ΔU_{OFFSET} , the offset value is automatically adjusted.

Setting Limit Values

Limits ΔU

Limit value: VDE < 4.00%

$\Delta U \% > \text{limit value}$

Red

TAB Limit value per German technical connection conditions for connection to low-voltage mains between the distribution network and the measuring device

DIN Limit value per DIN 18015-1: $\Delta U < 3\%$ between the measuring device and the consuming device

VDE Limit value per DIN VDE 0100-520: $\Delta U < 4\%$ between the distribution network and the consuming device (adjustable up to 10% in this case)

NL Limit value per NIV: $\Delta U < 5\%$

Measurement without OFFSET

Proceed as follows:

- Switch **OFFSET** from ON to OFF.

ON
START

Determine OFFSET (as %)

Proceed as follows:

- Switch **OFFSET** from OFF to ON. " $\Delta U_{\text{OFFSET}} = 0.00\%$ " is displayed.
- Connect the test probe to the point of common coupling (measuring device / meter).
- Start measurement of offset with $I_{\Delta N}$.

An intermittent acoustic signal sounds first, which is then accompanied by a blinking warning to prevent an offset value which has already been saved from being unintentionally deleted.

- Start the offset measurement by pressing the release key again or abort measurement by pressing the key **ON/START** (here = ESC).

OFFSET

ESC

CAL

ON
START

$\Delta U_{\text{OFFSET}} x.xx \%$ is indicated, where x.xx may take a value between 0.00 and 99.9 %.

An error message appears in a pop-up window in the event that $Z > 10 \Omega$.

Start Measurement with OFFSET

ON
START

14.2 Measuring the Impedance of Insulating Floors and Walls (standing surface insulation impedance) – Z_{ST} Function

Measuring Method

The instrument measures the impedance between a weighted metal plate and earth. Line voltage available at the measuring site is used as an alternating voltage source. The Z_{ST} equivalent circuit is considered a parallel circuit.

Connection and Test Set-Up

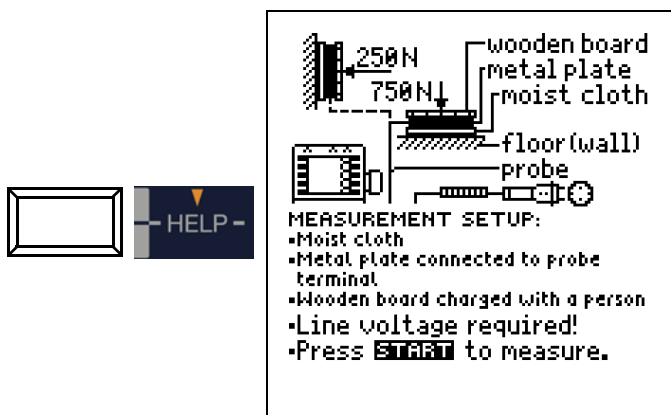
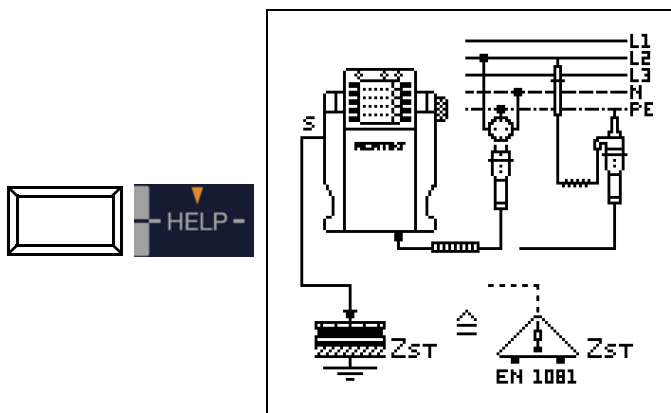

Note: Use the measuring set-up described in section 11.2 (triangular probe) or the one outlined below:

- Cover the floor or the wall at unfavorable locations, e.g. at joints or abutments, with a damp cloth measuring approx. 270 x 270 mm.
- Place the 1081 Probe on top of the damp cloth and load the probe with a weight of 750 N (75 kg, i.e. one person) for floors, or 250 N (25 kg) for walls, e.g. press against the wall with one hand which is insulated with a glove.
- Establish a conductive connection to the 1081 Probe, and connect it to the probe connector socket at the instrument.
- Connect the instrument to a mains outlet with the test plug.



Attention!

Do **not** touch the metal plate or the damp cloth with your bare hands.
No more than 50% line voltage may be applied to these parts! Current with a value of up to 3.5 mA may flow!
The measured value would be distorted as well.

Start Measurement

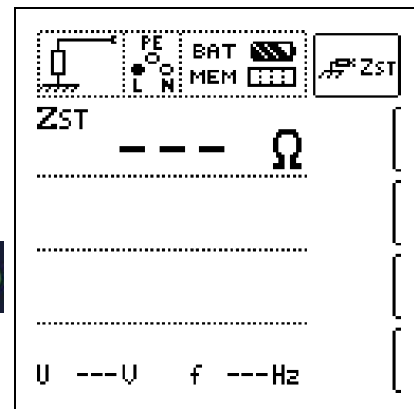

Evaluate Measured Value

The measured value has to be evaluated after measurement has been completed:

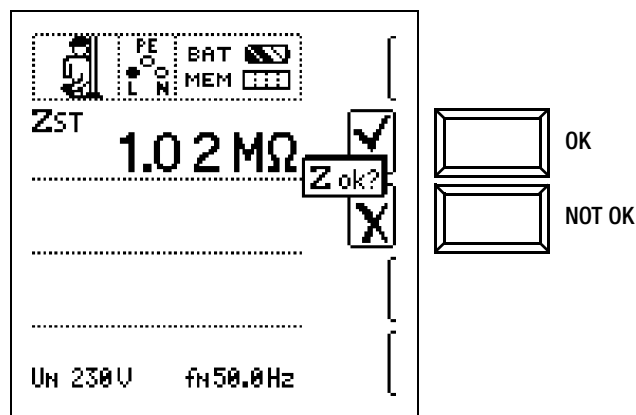

Resistance values must be measured at several points in order to provide for adequate evaluation. Measured resistance may not be less than 50 kΩ at any given point. If the measured value is greater than 30 MΩ, $Z_{ST} > 30.0 \text{ M}\Omega$ always appears at the display panel.

In the event that "NOT OK" is selected, an error is indicated by the **UL/RL LED** which lights up red.

See also Table 5 on page 89 with regard to evaluating measured values.

The measured value cannot be saved to memory and included in the test report until it has been evaluated.

Save Measured Value

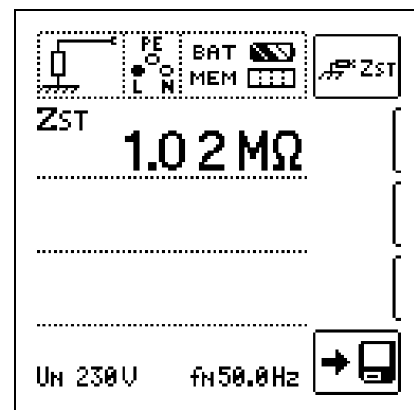

14.3 Testing Meter Start-Up with Earthing Contact Plug – kWh Function (not SECULIFE IP)

Energy consumption meters can be tested for correct start-up with this function.

Connection L – N

Earthing contact plug

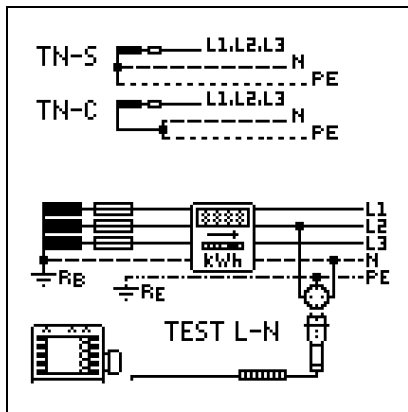

Start Measurement

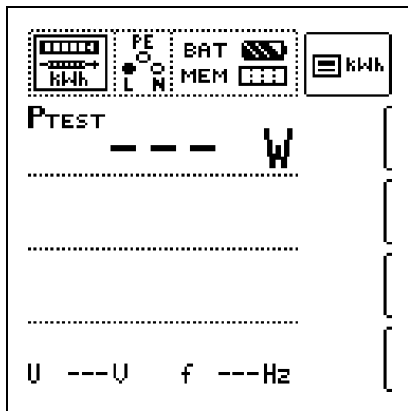

The meter is tested with the help of an internal load resistor and a test current of approximately 250 mA. After pressing the start key, test power is displayed and the meter can be tested for proper start-up within a period of 5 seconds. The "RUN" pictograph is displayed.

TN systems: All 3 phase conductors must be tested against N, one after the other.

In other types of systems, all phase conductors (active conductors) must be tested against one another.

Note

If minimum power is not reached, the test is either not started or aborted.

Save Measured Value

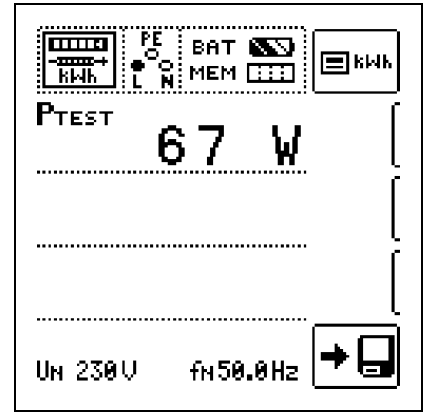

Special Case

Start-up of energy consumption meters which are connected between L and L or L and N can be tested with this function.

Connection L – L

2-Pole Adapter

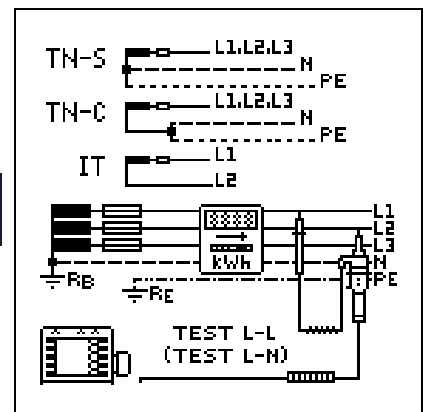

Note

If an earthing contact outlet is not available, you can use the 2-pole adapter. N must be contacted with the PE test probe (L2), and then measurement must be started.

If PE is contacted with the PE test probe (L2) during the meter start-up test, approximately 250 mA flow through the protective conductor and any upstream RCD is tripped.

Evaluate Measured Value

The measured value has to be evaluated after measurement has been completed:

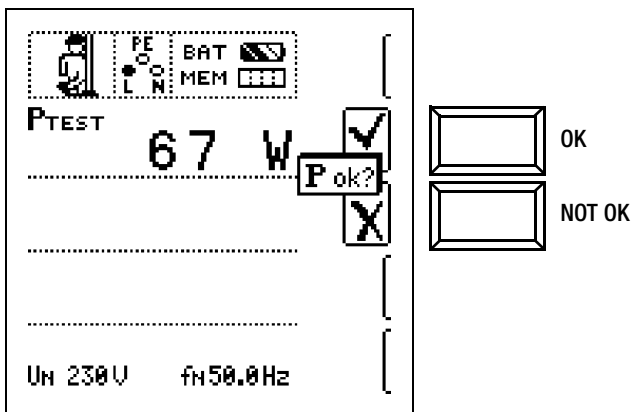

In the event that "NOT OK" is selected, an error is indicated by the **UL/RL LED** which lights up red.

The measured value cannot be saved to memory and included in the test report until it has been evaluated.

14.4 Leakage Current Measurement with PRO-AB Leakage Current Adapter as Accessory – I_L Function (PROFITEST MXTRA & SECULIFE IP only)

Applications

Measurement of contact voltage in accordance with DIN VDE 0107, part 10, as well as continuous leakage and patient auxiliary current per IEC 62353 (VDE 0750, part 1) / IEC 601-1 / EN 60601-1:2006 (Medical electrical equipment – General requirements for basic safety), is possible using the PRO-AB leakage current measuring adapter as an accessory with the PROFITEST MXTRA test instrument.

As specified in the standards listed above, current values of up to 10 mA may be measured with this measuring adapter. In order to be able to fully cover this measuring range using the measurement input provided on the test instrument (2-pole current clamp input), the measuring instrument is equipped with range switching between transformation ratios of 10:1 and 1:1. In the 10:1 range, voltage dividing takes place at the same ratio.

Connection and Test Set-Up

In order to perform the leakage current measurement, the adapter's measurement outputs must be plugged into the measurement inputs at the left-hand side of the PROFITEST MXTRA (2-pole current clamp input and probe input).

Either of the leakage current measuring adapter's inputs is connected to reference earth (e.g. safe earth electrode / equipotential bonding) via a measurement cable. The metallic housing (accessible part) of the device under test is contacted with a test probe or alligator clip which is connected to the other input by means of a second measurement cable.

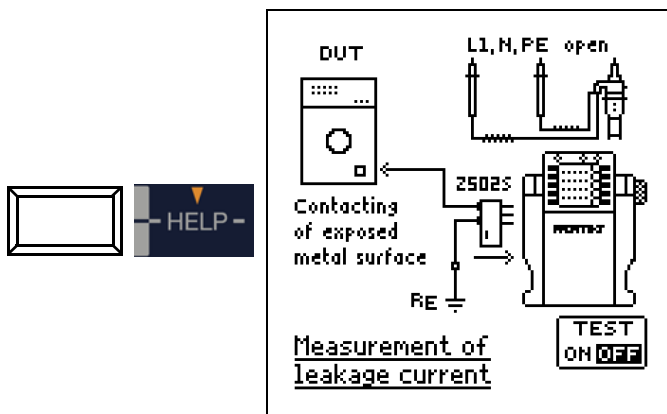

Testing the PRO-AB Adapter

The adapter should be tested before use and at regular intervals (see adapter operating instructions).

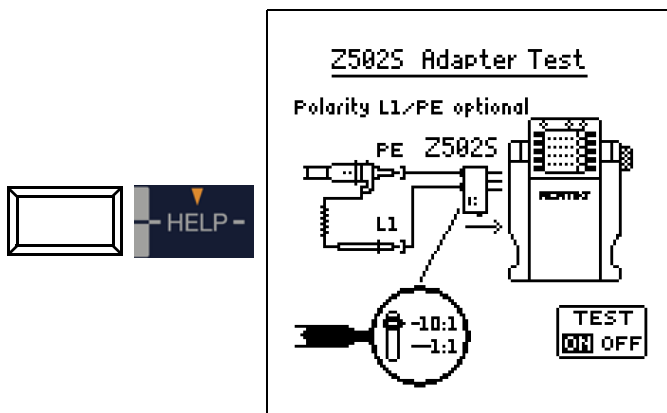

Measuring Sequence

Refer to the operating instructions for the PRO-AB leakage current measuring adapter regarding performance of the measurement.

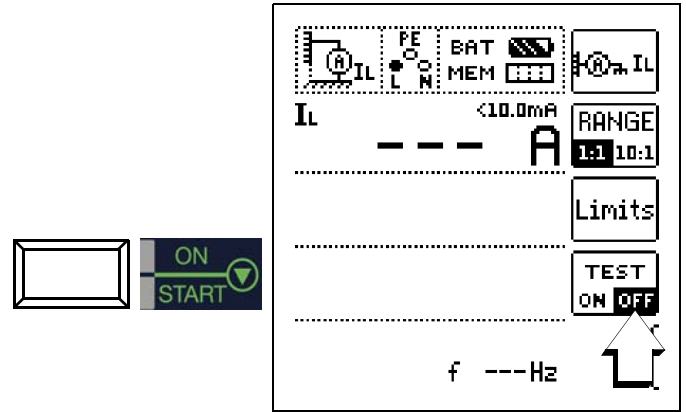

Attention!

The test plug should be located in the storage slot during leakage current measurement. Under no circumstances may the test plug be connected with any system components, including PE / ground potential (measured values might otherwise be distorted).

The measurement can be started or stopped by pressing the "START" key. Leakage current measurement is a long-term measurement, i.e. it continues until it is stopped by the user. The momentary measured value is displayed continuously during measurement.



Note

The self-test must be deactivated in the menu (set "TEST ON/OFF" function key to "OFF") in order to perform a measurement.

Always start with the large measuring range (10:1), unless there's no doubt that small measured values can be expected, in which case the small measuring range can be used (1:1). The measuring range must be selected at the measuring adapter, as well as in the menu using the corresponding function key (RANGE). It must be assured that the range settings at the adapter and at the test instrument are always identical, in order to prevent any distortion of measurement results.

Depending on the magnitude of the measured values, the range setting can, or must (in the case of overranging), be manually corrected at the measuring adapter and the test instrument.

Individual limit values can be adjusted after pressing the "Limits" function key. Exceeded limit values are indicated by the red limit value LED at the test instrument.

14.5 Testing of Insulation Monitoring Devices – IMD Function (PROFITEST MXTRA & SECULIFE IP only)

Applications

Insulation monitoring devices (IMDs) or earth fault detection systems (EDSs) are used in IT systems in order to monitor adherence to a minimum insulation resistance value, as specified by DIN VDE 0100-410.

They're used in power supplies for which a single-pole earth fault may not result in failure of the power supply, for example in operating rooms or photovoltaic systems.

Insulation monitors can be tested with the help of this special function. After pressing the **ON/START** button, an adjustable resistance is activated between one of the two phases of the IT system to be monitored and ground to this end. This resistance can be changed in the "MAN±" manual sequence mode with the help of the "+" or "-" softkey, or varied automatically from R_{max} to R_{min} in the "AUTO" operating mode. Testing is ended by once again pressing the **ON/START** key.

Time during which the momentary resistance value prevails since changing the value at the system is displayed. The IMD's display and response characteristics can be subsequently evaluated and documented with the help of the "OK" or "NOT OK" softkey.

Connection L – N

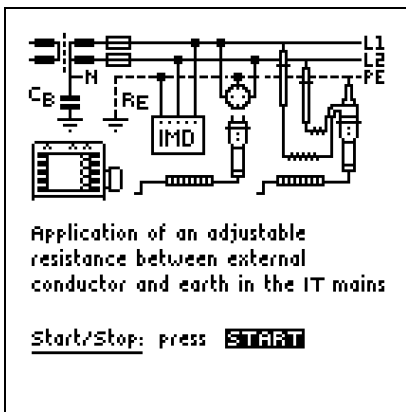

Set Parameters – MAN/AUTO (1)

Switch between manual measuring sequence **MAN** and automatic measuring sequence **AUTO**

– Change conductor relationship and limit values (2)

Quick switching between L1-PE and L2-PE (also during measurement) with the $I_{\Delta N}$ key

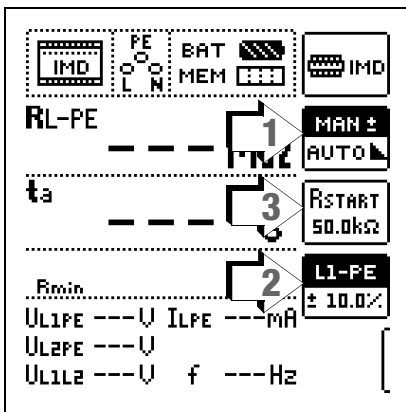

– Changing the initial resistance (3)

You can select the initial resistance here to start each series of measurements for manual measuring sequences.

The GOME setting (default settings) sets the initial value to a resistance value of 50.0 kΩ.

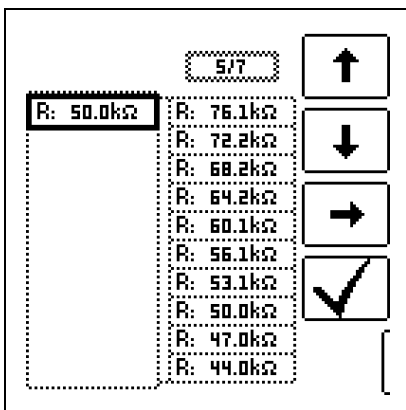

Set Limit Values for R_{L-PE} as %

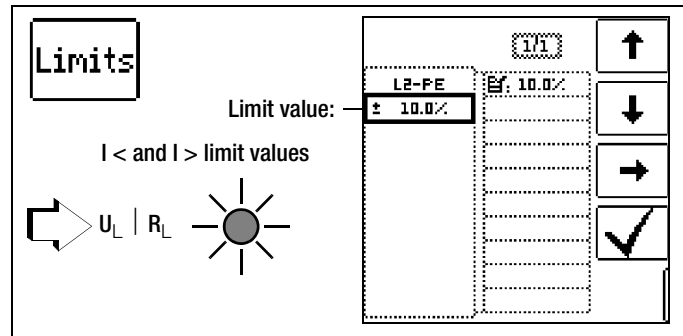

Limit values are calculated and displayed as a percentage of the momentarily displayed R_{L-PE} value.

Manual Measuring Sequence

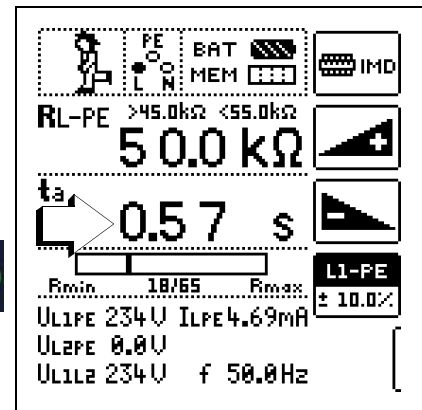

The measurement and the stopwatch (see arrow) are started with the "START" key.

The stopwatch is restarted each time the resistance value is changed and whenever the energized phase conductor is switched (L1/L2).

During measurement, the conductor relationship (L1-PE or L2-PE) can be changed with the $I_{\Delta N}$ key or the resistance value can be adjusted with the + and - keys, without interrupting the measurement. The stopwatch is reset in both cases.



Increasing + or Decreasing - the Resistance Value (The setting values themselves are fixed!)

The bar graph display provides you with quick orientation. The numeric combination which appears below it indicate the momentary step from as many as 65 steps (in this case step 17 of 65).

Automatic Measuring Sequence

In the case of the automatic measuring sequence, the sequence runs through all resistance values from the maximum to the minimum value (R_{max} (2,51 MΩ) to R_{min} (20 kΩ)) in 65 steps, and dwell time for each step is 2 seconds.

Evaluation

In order to evaluate the measurement, it must be stopped. This applies to manual as well as automatic measurement. Press the "START" or "ESC" key to this end. The stopwatch is stopped and the evaluation window appears.

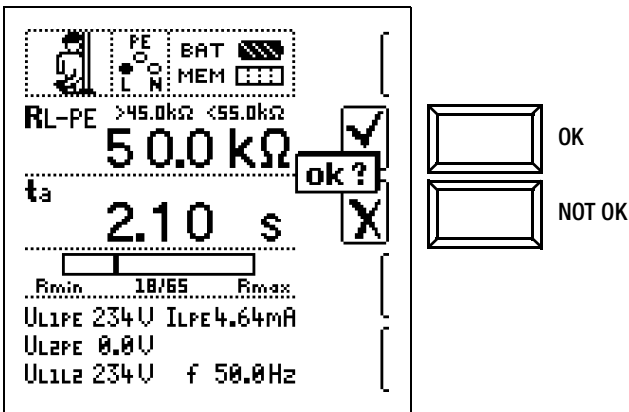

Press the "NOT OK", "START" or "ESC" key in order to reject the measurement.

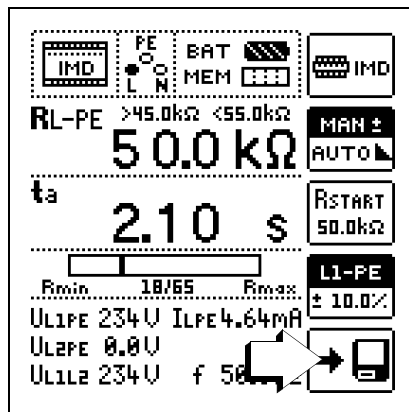

Retrieving Saved Measured Values

The measured value cannot be saved to memory and included in the test report until it has been evaluated (see also section 16.4).

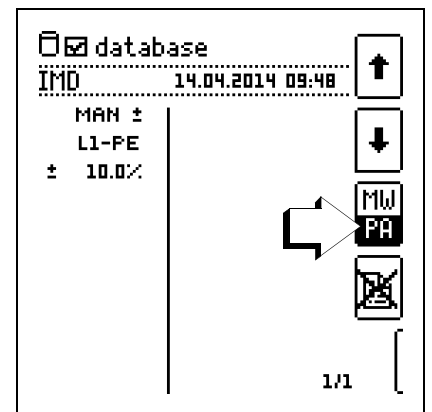
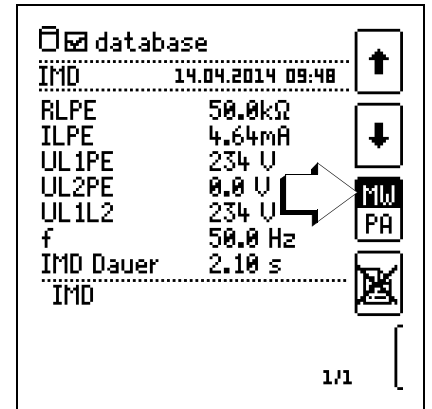

With the help of the key shown at the right (MW: measured value / PA: parameter), the setting parameters can be displayed for this measurement.



14.6 Residual Voltage Test – Ures Function (PROFITEST MXTRA only)

Applications

The EN 60204 standard specifies that after switching supply power off, residual voltage must drop to a value of 60 V or less within 5 seconds at all accessible, active components of a machine to which a voltage of greater than 60 V is applied during operation.

With the PROFITEST MXTRA, testing for the absence of voltage is performed as follows by means of a voltage measurement which involves measuring discharge time t_u :

In the case of voltage dips of greater than 5% of momentary line voltage (within 0.7 seconds), the stopwatch is started and momentary undervoltage is displayed as **Ures** after 5 seconds, and indicated by the red UL/RL LED.

The function is ended after 30 seconds, after which Ures and t_u data can be deleted and the function can thus be restarted by pressing the ESC key.

Measuring Sequence – Long-Term Measurement

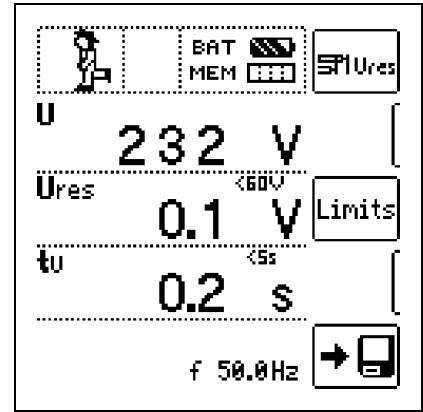

Testing is selected as a continuous measurement because residual voltage testing is triggered automatically and voltage measurement is always active for safety reasons.

Connection

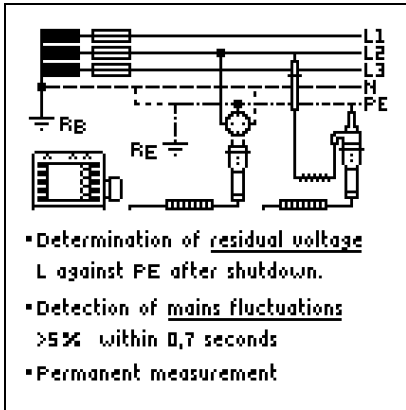

Note

If, for example, conductors are exposed when a machine is switched off – e.g. if plug connectors are disengaged – which are not protected against direct contact, maximum allowable discharge time is 1 second!

Limit Values

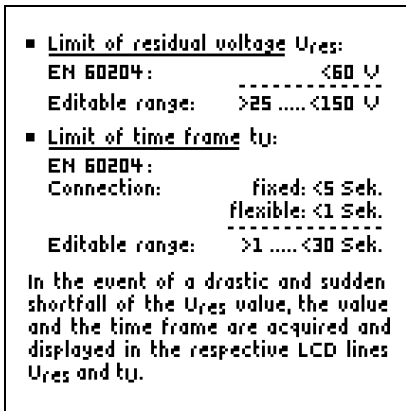

Setting Limit Values

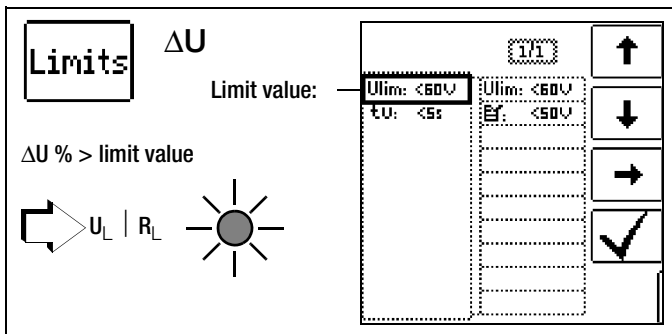

14.7 Intelligent Ramp – t_a+I_Δ Function (PROFITEST MXTRA only)

14.7.1 Applications

The advantage of this measuring function in contrast to individual measurement of $I_{\Delta N}$ and t_a is the simultaneous measurement of breaking time and breaking current by means of a test current which is increased in steps, during which the RCD is tripped only once.

The intelligent ramp is subdivided into time segments of 300 ms each between the initial current value (35% $I_{\Delta N}$) and the final current value (130% $I_{\Delta N}$). This results in a gradation for which each step corresponds to a constant test current which is applied for no longer than 300 ms, assuming that tripping does not occur.

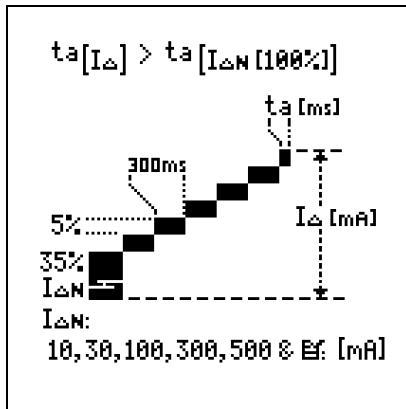

And thus both tripping current and tripping time are measured and displayed.

Connection

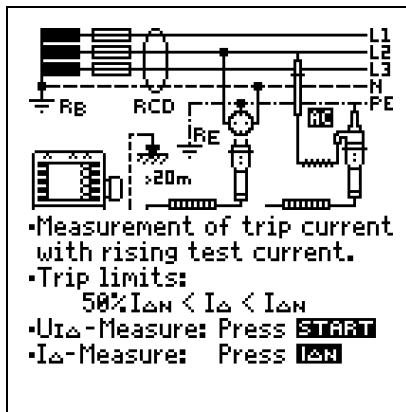

Set Parameters

Start Contact Voltage Measurement



Start Tripping Test



The measurement sequence can be broken off prematurely at any time by pressing the ON/START key.

Measurement Results

14.8 Testing Residual Current Monitors – RCM Function (PROFITEST MXTRA only)

General

Residual current monitors (RCMs) monitor residual current in electrical systems and display it continuously. As is also the case with residual current devices, external switching devices can be controlled in order to shut down supply power in the event that a specified residual current value is exceeded.

However, the advantage of an RCM is that the user is informed of fault current within the system before shutdown takes place.

As opposed to individual measurement of $I_{\Delta N}$ and t_A , measurement results must be evaluated manually in this case.

If an RCM is used in combination with an external switching device, the combination must be tested as if it were an RCD.

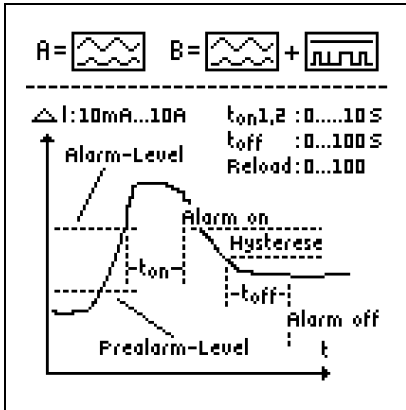

Connection

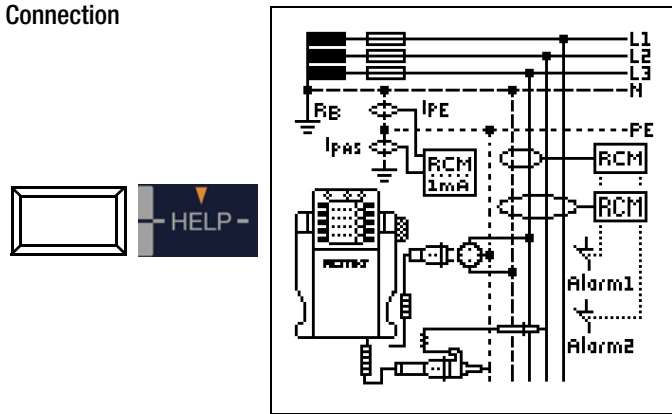

Measure Contact Voltage

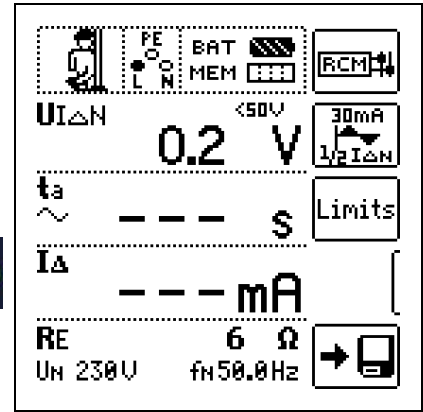

Non-Tripping Test with $1/2 \times I_{\Delta N}$ and 10 s

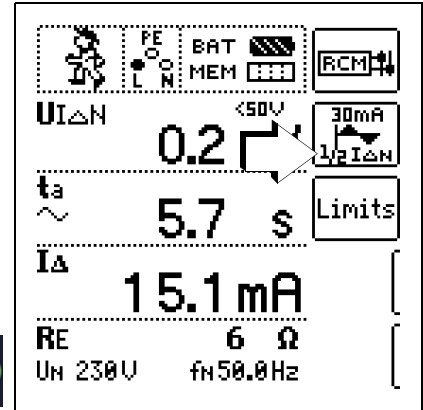

After 10 seconds have passed, no fault current may be signalled. The measurement must be evaluated afterwards. In the event that "NOT OK" is selected (in case of false alarm), an error is indicated by the UL/RL LED which lights up red.

The measured value cannot be saved to memory and included in the test report until it has been evaluated.

Set Parameters for $I_{\Delta N}$

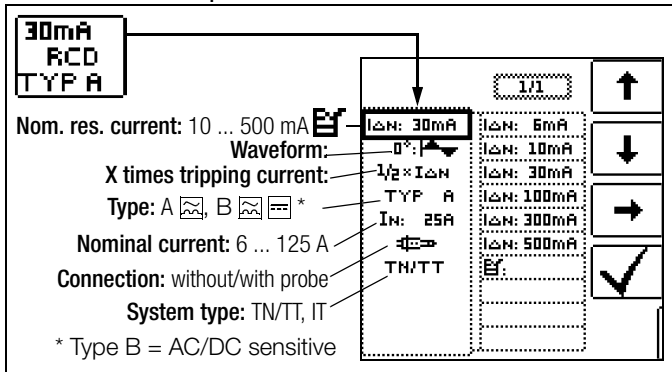

Tripping Test with $1 \times I_{\Delta N}$

– Measurement of Signal Response Time (stopwatch function) with the Residual Current Generated by the Test Instrument

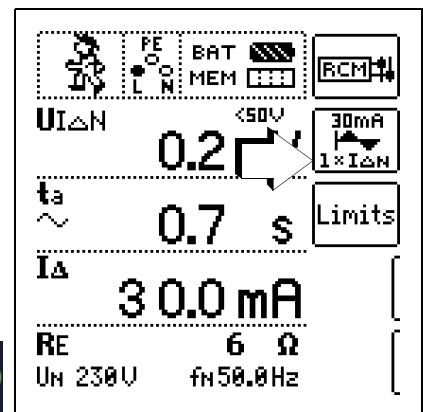

In order to document the tripping time, the measurement must be stopped manually with the ON/START or $I_{\Delta N}$ key immediately after the fault current has been signalled.

In the event that "NOT OK" is selected, an error is indicated by the UL/RL LED which lights up red.

The measured value cannot be saved to memory and included in the test report until it has been evaluated.

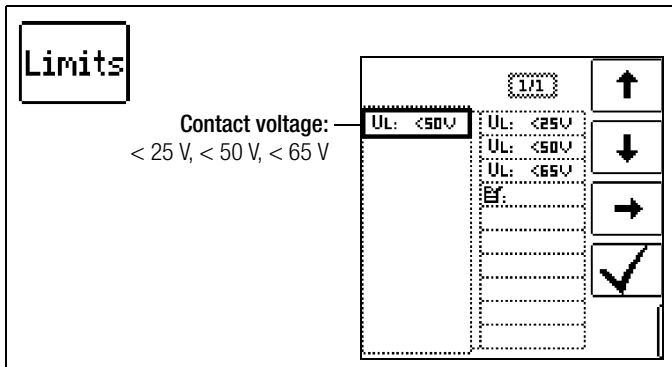

14.9 Testing the Operating States of Electric Vehicles at Charging Stations per IEC 61851 (MTECH+ & MXTRA only)

A charging station is an equipment designed for the charging of electric vehicles per IEC 61851 which essentially consists of a plug connector, a cable protection, a residual current device (RCD), as well as a circuit breaker and a security communication system (PWM). Depending on the place of installation and application, further functional features such as mains connection and meter may be included.

Adapter selection (test box)

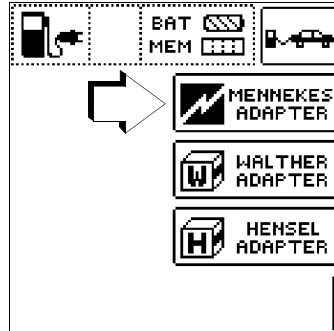

Simulation of operating states per IEC 61851 with the MENNEKES test box (Status A – E)

The MENNEKES test box only serves the purpose of simulating different operating states of an electric vehicle fictitiously connected with a charging station. The settings for the simulated operating states are indicated in the operating instructions for the test box.

The simulated operating states can be stored in the MTECH+ or MXTRA as visual inspection and documented in the ETC software. The operating state (status) to be tested is selected with the **SELECT STATUS** key at the MTECH+ or MXTRA test instrument.

Status A – Charging conductor only connected with charging point

- CP signal is switched on,
- voltage between PE and CP is 12 V.

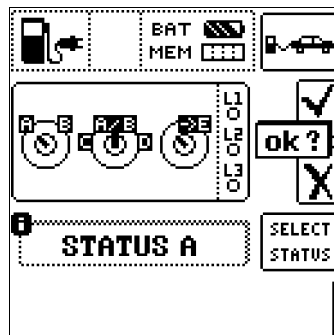

Status B – Charging conductor connected with charging point and vehicle

- the charging conductor is locked at the charging point and in the vehicle,
- vehicle not yet ready for charging,
- voltage between PE and CP is +9 V / -12 V.

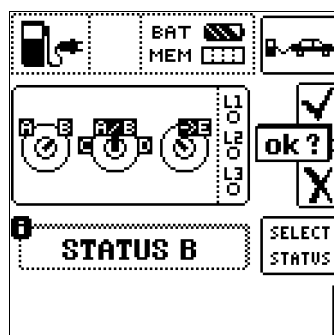

Status C – Non-gassing vehicle identified

- Readiness for charging on the vehicle/power side is activated,
- Voltage between PE and CP is +6 V / -12 V.

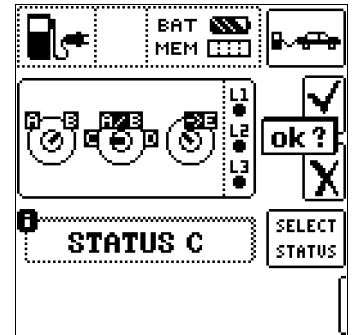

Status D – Gassing vehicle identified

- Readiness for charging on the vehicle/power side is activated,
- Voltage between PE and CP is +3 V / -12 V.

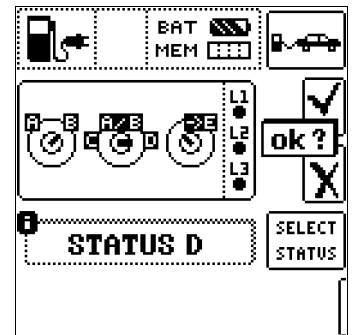

Status E – Conductor is damaged

- Short circuit between PE and CP,
- Charging conductor is unlocked at the charging point,
- Voltage between PE and CP is +0 V.

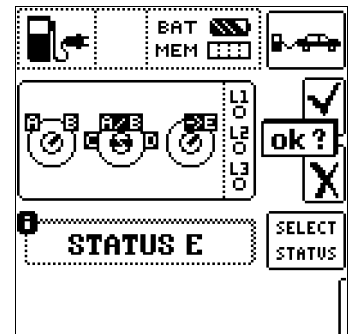

Semi-automatic changing between operating states

As an alternative to the manual changing between operating states via the parameter menu of the **SELECT STATUS** softkey at the test instrument, there is another fast and convenient way of changing between the operating states: select status parameter **AUTO**. Each time after replying to and storing a visual inspection, an automatic changeover to the next state takes place, with the keys shown on the display corresponding to **01/05 A/E** (01 = A, 02 = B, 03 = C, 04 = D, 05 = E). It is possible to skip the status variants by pressing key $I_{\Delta N}$ at the test instrument or at the test socket.

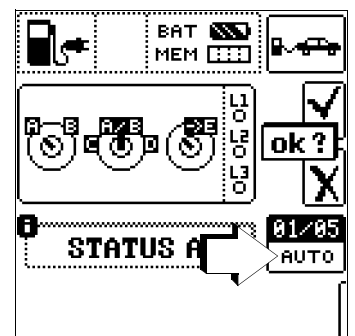

14.10 Test Sequences for Report Generation of Fault Simulations on PRCDs with PROFITEST PRCD Adapter (MXTRA only)

The following functions can be performed when the PROFITEST MXTRA test instrument is connected with the PROFITEST PRCD test adapter:

- Three test sequences are preconfigured:
 - PRCD-S (single phase/3-pole)
 - PRCD-K (single phase/3-pole)
 - PRCD-S (three-phase/5-pole)
- The test instrument guides you through all test steps in a semi-automatic fashion:
 - Single phase PRCDs:
 - PRCD-S: 11 test steps
 - PRCD-K: 4 test steps
 - 3-phase PRCDs:
 - PRCD-S: 18 test steps
- Each test step is assessed and evaluated by the user (OK/not OK) for subsequent report generation purposes.
- Measurement of protective conductor resistance of the PRCD by means of function R_{LO} at the test instrument. Please note that the protective conductor measurement represents a modified RLO measurement with ramp curve for PRCDs, see section 12.
- Measurement of insulation resistance of the PRCD by means of function R_{INS} at the test instrument, see section 11.
- Trip test with nominal fault current by means of function I_F at the test instrument, see section 7.3.
- Measurement of tripping time by means of function $I_{\Delta N}$ at the test instrument, see section 7.3.
- Varistor test with PRCD-K: measurement via ISO ramp, see section 11.



Attention!

It is imperative that you read the operating instructions for PROFITEST PRCD before connecting the PROFITEST MXTRA with the PRCD adapter.

14.10.1 Selecting the PRCD under Test

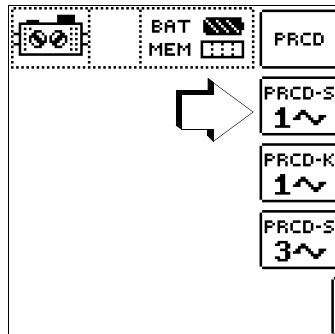

14.10.2 Parameter Settings

Meaning of Symbols for the Respective Fault Simulation

Switch Position	Symbols shown at PROFITEST MXTRA		Meaning of Symbols
PROFITEST PRCD	Parameter Setting	Menu Display	
	ON	1~ON	Activate single phase PRCD
	ON	3~ON	Activate 3-phase PRCD
	BREAK Lx		Disconnection of conductor
	Lx <-> PE Lx <-> N		Conductor exchange between phase conductor and PE or neutral conductor
PE-U _{EXT}	Uext -> PE	PE-U _{EXT}	PE to phase
	PROBE		Contact key ON at PRCD with probe
	PRCD-Ip		Protective conductor current measurement with current clamp transformer
—	AUTO	AUTO	Semi-automatic changing of fault simulations

Parameter PRCD-S single phase – 11 parameters = 11 test steps

Together with the required intermediate steps for PRCD activation (=ON), the parameters for the fault simulations represent die 11 potential test steps:

Interruption (BREAK...), conductor exchange (L1 <-> PE), PE to phase (Uext -> PE), contacting of key ON, protective conductor current measurement (Figure on the right: PRCD-Ip).

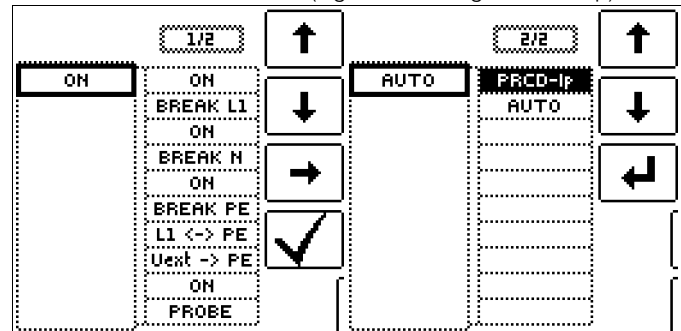

Parameter PRCD-S 3-phase – 18 parameters = 18 test steps

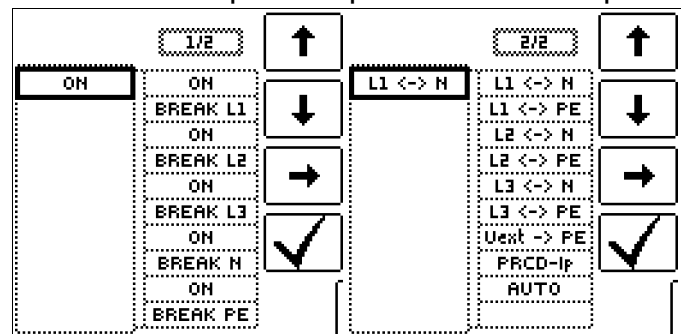

Parameter PRCD-K single phase – 5 parameters = 5 test steps

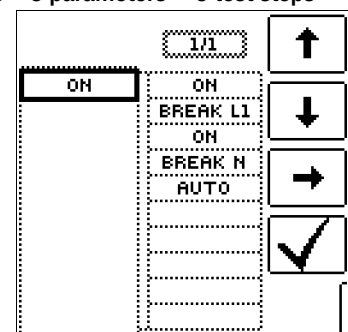

14.10.3 Test Sequence PRCD-S (single phase) – 11 Test Steps

Selection Examples

Simulation Interruption (Steps 1 to 6)

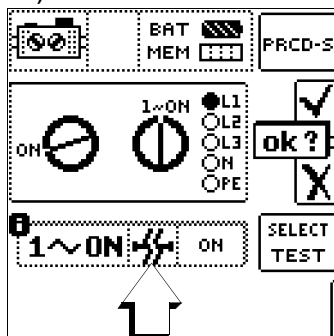

Simulation Conductor Exchange (Step 7)

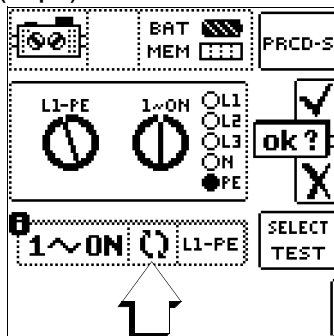

Simulation PE to Phase (Step 8)

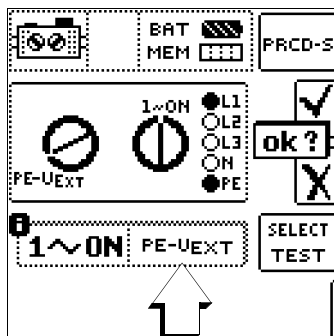

Contacting Key ON at PRCD with Probe (Step 10)

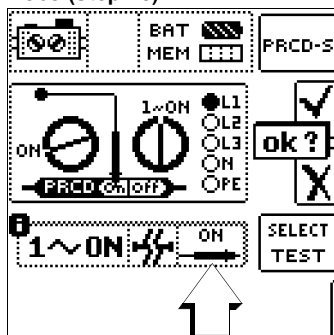

Measurement of Protective Conductor Current with a Current Clamp Transformer (Step 11)

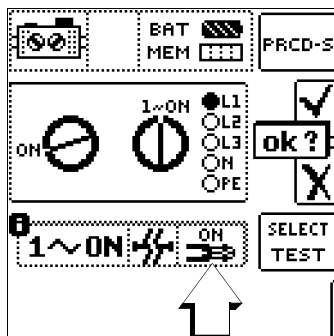

Selection Examples

Simulation Interruption (Steps 1 to 10)

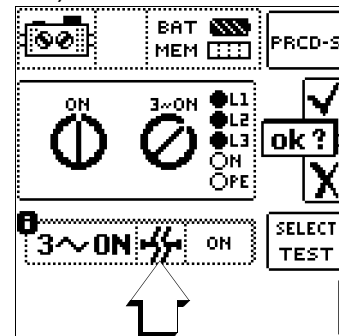

Simulation Conductor Exchange (Steps 11 to 16)

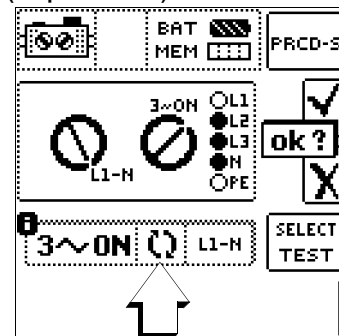

Simulation PE to Phase (Step 17)

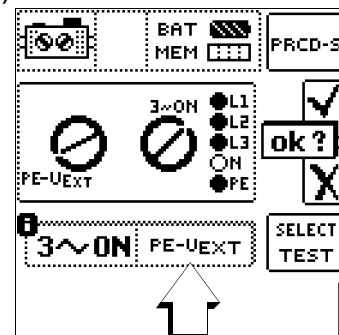

Measurement of Protective Conductor Current with Current Clamp Transformer (Step 18)

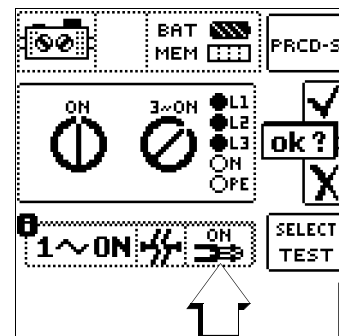

Semi-automatic Change of Fault Simulations (Statuses)

As an alternative to changing manually between the fault simulations via the parameter menu of the respective PRCD selection PRCD-S 1~, PRCD-K 1~ or PRCD-S 3~ at the test instrument, it is possible to switch quickly and conveniently between the fault simulations. Select status parameter **AUTO** for this purpose. After replying to and storing each visual inspection, an automatic switch-over to the next fault simulation takes place. Individual fault simulations can be skipped by pressing key $I_{\Delta N}$ at the test instrument or at the test plug.

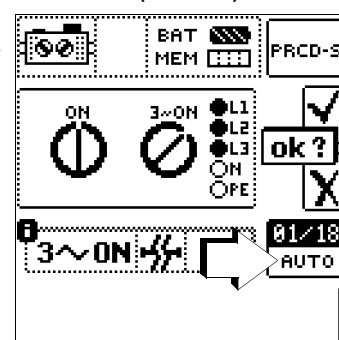

14.10.4 Test Sequence PRCD-S (three-phase) – 18 Test Steps

15 Automatic Test Sequences – AUTO Function

If the same order of tests with subsequent report generation is to be performed repeatedly, as is, for example, specified by certain standards, we recommend using test sequences.

With the help of test sequences it is possible to compile automatic test procedures on the basis of the manual individual measurements. A test sequence consists of up to 200 individual test steps which have to be processed one after the other.

Basically, a distinction is made between three types of individual steps:

- **Note:** the test procedure is interrupted by a pop-up note for the test engineer. It is not continued before the test engineer acknowledges the note.
Example: Note prior to insulation resistance measurement: „Disconnect the device from the mains!“
- **Visual inspection, testing and report:** the test procedure is interrupted by a pop-up window of a passed/failed evaluation, comments on and results of the evaluation are saved in the database.
- **Measurement:** Measurement like the individual measurements performed by the test instruments with data storage and parameter configuration.

The test sequences are created at a PC by means of the ETC software and are then transferred to the test instruments.

The measurement parameters are also configured at a PC. However, they can still be modified at the test instrument during the test procedure before the respective measurement is launched. After restarting the test step, the parameter settings defined in ETC are loaded.

Note

The parameters are not subjected to a plausibility check by the ETC software. We therefore advise you to test the newly created test sequence at the test instrument before filing it permanently in your database.

Limit values are currently not defined in ETC, but have to be adjusted during the automatic test sequence.

Menu for the Processing of Test Sequences

In order to process existing test sequences, to add, for example, further test sequences or to adjust parameter settings, they have to be loaded to the ETC PC software beforehand.

There are two possibilities to do this:

- ETC: Extras → Test sequences → Load test sequences (from file „pruefsequenzenxyz.seq“)

or

- ETC: Device → Test sequences → Receive test sequences (from the connected test instrument **PROFITEST MPRO** or **PROFITEST MXTRA**)

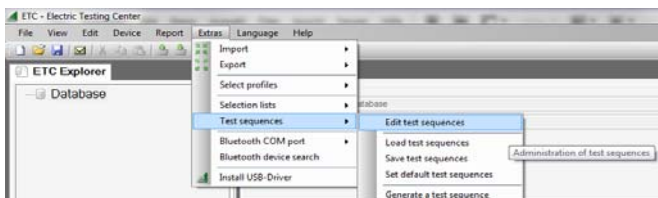

Step-by-step Overview: Generating Test Sequences at the PC

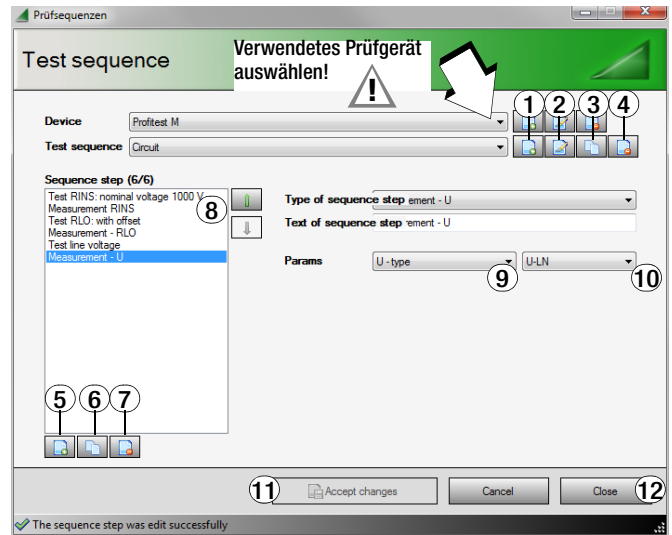

- 1 Generate new test sequence – enter denomination
- 2 Change denomination of the selected test sequence
- 3 Duplicate selected test sequence, (copy) is added at the end of the duplicated name
- 4 Delete selected test sequence
- 5 Generate and/or add new test step for selected test sequence – Choose the type of test step from the list and accept or modify the denomination
- 6 Duplicate selected test step
- 7 Delete selected test step
- 8 Change the order of the selected test steps
- 9 Select measuring parameters for the selected type of test step from the list
- 10 Choose the setting for the measuring parameters from the list
- 11 Accept modification for the measuring parameter
- 12 Close test sequence menu

Saving Test Sequences to the ETC Software at the PC

We recommend saving the test sequences of the default setting, modified as well as newly created test sequences via command „Extras → Test sequences → Save test sequences“ to the PC or other storage media under a file name (testsequencesxyz.seq). This helps to prevent data loss as a result of certain administrative operations, see the following remarks.

As a maximum of 10 test sequences can be transferred to the test instrument, it is not possible to save more than 10 test sequences in one file.

Via command „Extras → Test sequences → Load test sequences“ the test sequences saved to a file can be reloaded to the ETC software at any time.

For subsequent processing select command „Extras → Test sequences → Edit test sequences“.

Please note that the active test sequences in the ETC software are deleted by the following operations:

- by receiving test sequences from the test instrument (ETC: Device → Test sequences → Receive test sequences)
- by changing the user language (ETC: Language → ...)
- by saving the data from the test instrument (ETC: Device → Backup/Restore → Backup)

Please note that the test sequences loaded to the test instrument are deleted by the following operations in the test instrument:

- by receiving selection lists from the PC (ETC: Device → Selection lists → Transmit selection lists)
- by receiving new test sequences from the PC (ETC: Device → Test sequences → Send test sequences)
- by transmitting the saved data to the test instrument (ETC: Device → Backup/Restore → Restore)
- by resetting to default settings (Switch position SETUP → key GOME SETTING)
- by firmware updates
- by changing the user language (Switch position SETUP → key CULTURE)
- by deleting the entire database in the test instrument

Transferring Test Sequences from the PC to the Test Instrument

After activating the ETC command „Device → Test sequences → Send test sequences“ all test sequences that have been created (maximum of 10) are transferred to the connected test instrument.

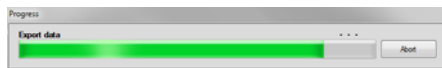
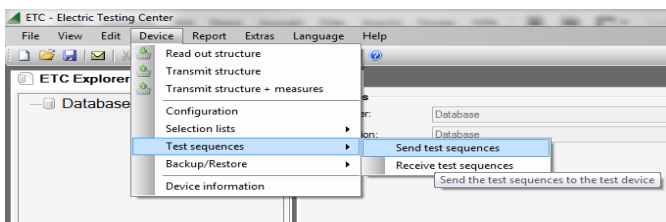

During the transfer of the test sequences the above progress bar-graph is shown at the PC screen and the righthand image appears on the display of the test instrument.

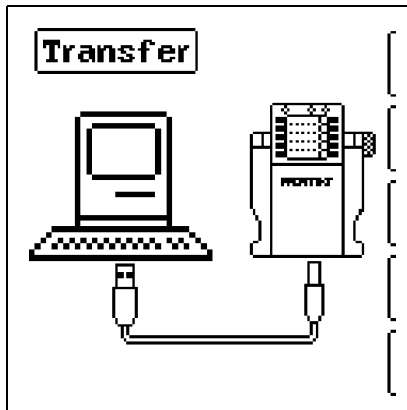

After the data transfer has been completed, the display switches to the storage menu „database“.

By pressing **ESC** you proceed to the measurement menu display of the current switch position.

Selecting Switch Position AUTO at the Test Instrument



When the rotary switch is set to AUTO, all existing test sequences in the instrument are displayed, see figure 15.1.

If there are no test sequences in the instrument, message „NO DATA“ appears.

Selecting and Starting a Test Sequence at the Test Instrument

Figure 15.1

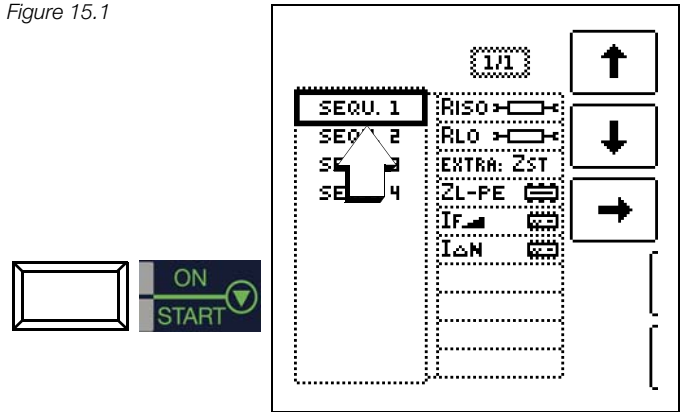

Press the **START** key to launch the selected test sequence (here: SEQU.1).

When executing a test step of the measurement type, the display structure known from the individual measurements is shown. Instead of the storage and battery symbol, the current test step number is shown in the header (here: step 01 of 06), see figure 15.2. The next test step is shown after pressing the „Save“ key twice.

Setting Parameters and Limit Values

Parameters and limit values can also be modified while performing a test sequence or before starting the measurement. This modification only affects the active test procedure and is not saved.

Skipping of Test Steps

There are two possibilities to skip test steps and/or individual measurements:

- Activate test sequence, switch to the right-hand test step column with the cursor, select the xth test step and press key **START**.
- Within a test sequence, the navigation menu is activated by pressing the navigation key Cursor left-right. Switch to the previous or next test step with the cursors which are now displayed separately. Leave the navigation menu and reactivate the current test step with **ESC**.

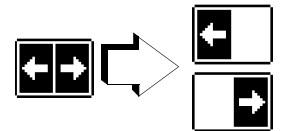

Interrupt or Abort a Test Sequence

An active sequence is aborted with **ESC** and subsequent confirmation.

When the last test step is completed, the message „Sequence completed“ is shown. After confirming this message, the start menu „List of test sequences“ appears on the display.

Figure 15.2

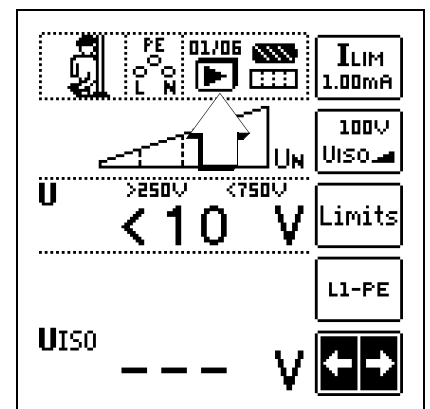

16 Database

16.1 Creating Distributor Structures, General

A complete distributor structure with data for electrical circuits and RCDs can be created in the **PROFITEST MASTER** test instrument. This structure makes it possible to assign measurements to the electrical circuits of various distributors, buildings and customers.

There are two possible procedures:

- On location or at the construction site:
Create the distributor structure in the test instrument.
A distributor structure with up to 50,000 structural elements can be created in the test instrument, which is saved to the instrument's flash memory.

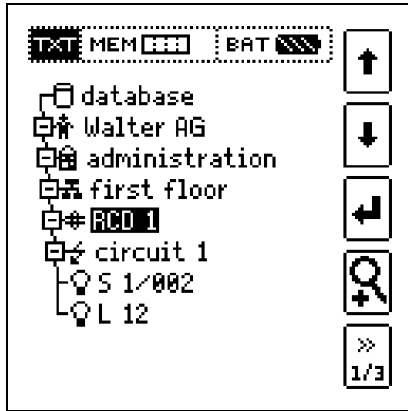

or

- Create and save an image of an existing distributor structure at a PC with the help of **ETC report generating software** (Electric Testing Center) (see condensed operating instructions for ETC report generating software). The distributor structure is then transferred to the test instrument.

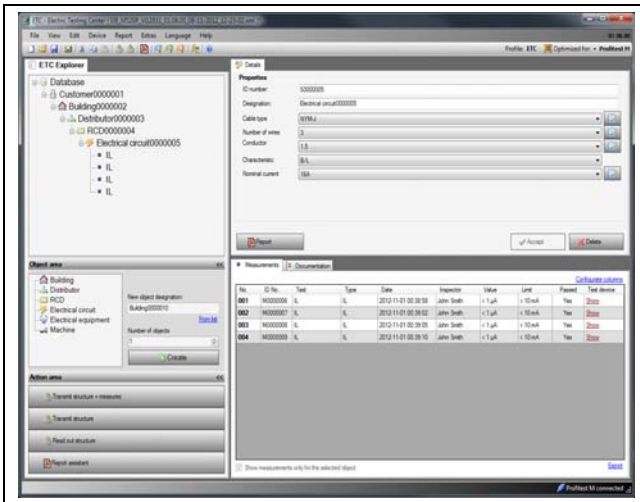

Note regarding ETC Report Generating Software

The following steps must be completed before using the software:

- Install USB device drivers:**
(required for operation of **PROFITEST MASTER** with a PC)
GMC-I Driver Control software can be downloaded from Gossen Metrawatt's website at:
<http://www.gossenmetrawatt.com>
→ Products → Software → Software for Testers
→ Utilities → **Driver Control**
- Install ETC report generating software:**
You can download the current ETC version free of charge from our homepage under section **mygmc** after registration or login:
<http://www.gossenmetrawatt.com>
→ Products → Software → Software for Testers
→ Protocol Software without Database → **ETC** → **myGMC** → **zum Login**

16.2 Transferring Distributor Structures

The following data transfer operations are possible:

- Transfer a distributor structure from the PC to the test instrument.
- Transfer a distributor structure including measured values from the test instrument to the PC.

The test instrument and the PC must be connected with a USB cable in order to transfer distributor structures and data.

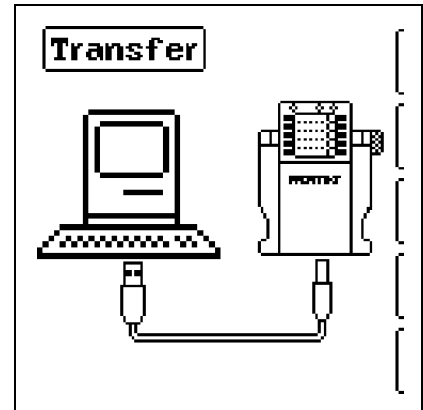

The following image appears at the display during transfer of structures and data.

16.3 Creating a Distributor Structure in the Test Instrument

Overview of the Meanings of Icons used to Create Structures

Icon	Meaning
Main Level	Sub-Level
	Memory menu, page 1 of 3
	Cursor UP: scroll up
	Cursor DOWN: scroll down
	ENTER: acknowledge selection + → - change to sub-level (open directory) or - → + change to main level (close directory)
	Display of complete structure designation (max. 63 characters) or ID number (max. 25 characters) in a zoom window
	Temporarily switching back and forth between structure designation and ID number. These keys do not interfere with the main configuration in the setup menu, see DB MODE on page 11.
	Hide structure designation or ID number
	Change display to menu selection
	Memory menu, page 2 of 3
	Add a structural element
	Meaning of icons from top to bottom: Customer, building, distributor, RCD, electrical circuit, operating equipment, machine and earth electrode (display of the icons depends on the selected structural element). Selection: UP/DOWN scroll keys and ↵ In order to add a designation to the selected structural element, refer to edit menu in following column.
	EDIT
	Delete the selected structural element.

Icon	Meaning
	Show measurement data, if a measurement has been performed for this structural element.
	Edit the selected structural element.
Memory menu, page 3 of 3	
	Search for ID number. > Enter complete ID number.
	Search for text. > Enter full text (complete word).
	Search for ID number or text.
	Continue searching.
Edit menu	
	Cursor LEFT: Select an alphanumeric character
	Cursor RIGHT: Select an alphanumeric character
	ENTER: accept an individual character
<input checked="" type="checkbox"/>	Acknowledge entry
←	Cursor left
→	Cursor right
	Delete characters
	Switching amongst different types of alphanumeric characters:
A	✓ ABCDEFGHIJK Upper case letters LMNOPQRSTUVWXYZ XYZ ↵ ⇐⇒
a	✓ abcdefghijk Lower case letters lmnopqrstuvwxyz xyz ↵ ⇐⇒
0	✓ 0123456789+ Numbers -*/=:;_<(> .!? ↵ ⇐⇒
@	✓ @# \$% & ' () * + , - : ; < > [\] ^ _ ` { } ~ ! " # \$ % & ' () * + , - : ; < > [\] ^ _ ` { } ~ ↵ ⇐⇒ Special characters

Distributor Structure Symbology / Tree Structure

A **check mark** to the right of a structural element means that all measurements within the respective hierarchy have been passed.

Symbol x: at least one measurement has not been passed.

No symbol: Measurement has not yet been performed.

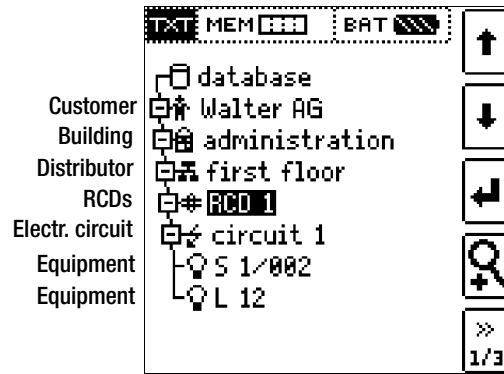

Same type of element as in the Windows Explorer:

+ : sub-object available, display by pressing ↵.

- : sub-objects are displayed, hide by pressing ↵.

16.3.1 Creating Structures (example for electrical circuit)

After selection with the **MEM** key, all setting options for the creation of a tree structure are made available on three menu pages (1/3, 2/3 and 3/3). The tree structure consists of structural elements, referred to below as objects.

Select the position at which a new object will be added.

Use the ↑↓ keys in order to select structural elements.

Change to the sub-level with the ↵ key.

Go to the next page with the >> key

Create a new object.

Press the key in order to create a new object.

Select a new object from a list.

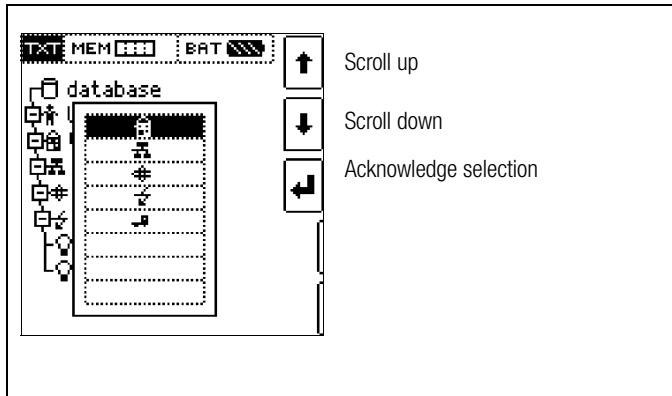

Select the desired object from the list with the ↑↓ keys and acknowledge with the ↵ key.

Depending upon the profile selected in the test instrument's SETUP menu (see section 4.6), the number of object types may be limited, and the hierarchy may be laid out differently.

Enter a designation.

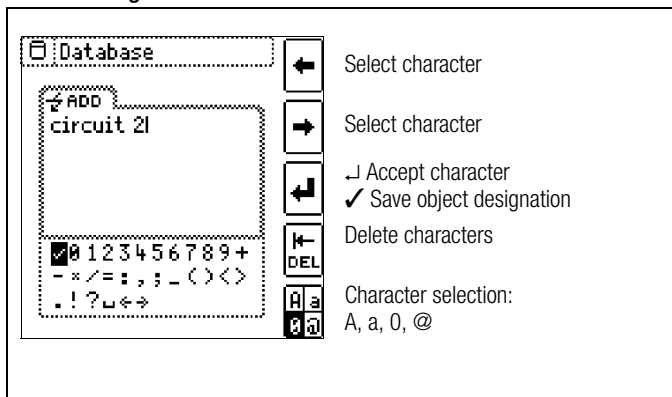

Enter a designation and then acknowledge it by entering a ✓.



Note

Acknowledge the standard or adjusted parameters shown below, because the created designation will otherwise not be accepted and saved.

Set Electrical Circuit Parameters

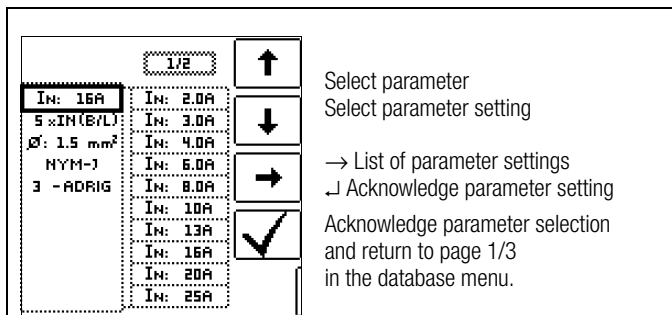

For example, nominal current values must be entered here for the selected electrical circuit. Measuring parameters which have been accepted and saved in this way are subsequently accepted by the current measuring menu automatically when the display is switched from the structural view to measurement.



Note

Electrical circuit parameters changed during structure creation are also retained for individual measurements (measurement without saving data).

If you change the electrical circuit parameters defined in the structure of the test instrument, a warning is issued upon saving, see error message on page 81.

16.3.2 Searching for Structural Elements

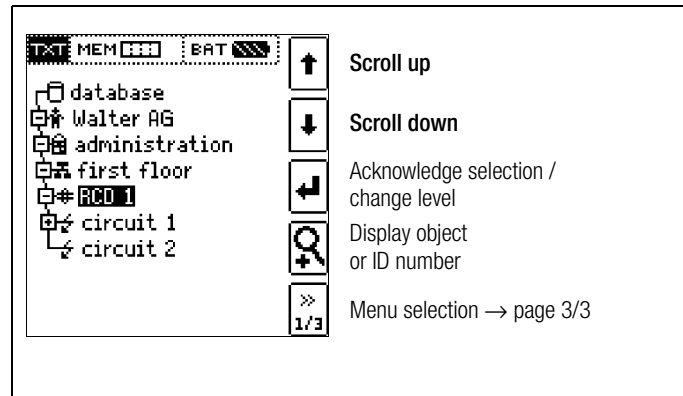

The search always starts with **database**, regardless of the currently marked object.

Go to page 3/3 in the database menu.

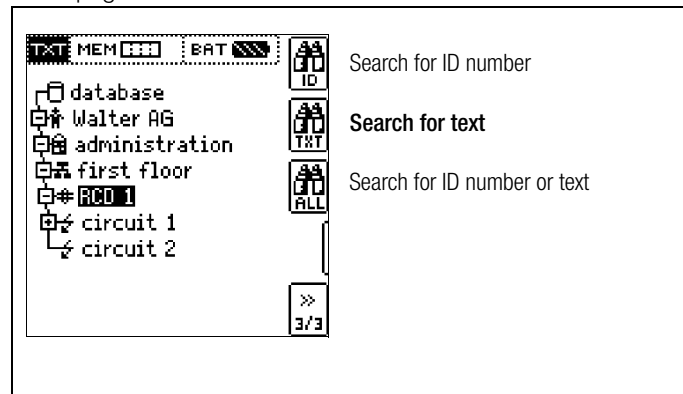

After selecting text search

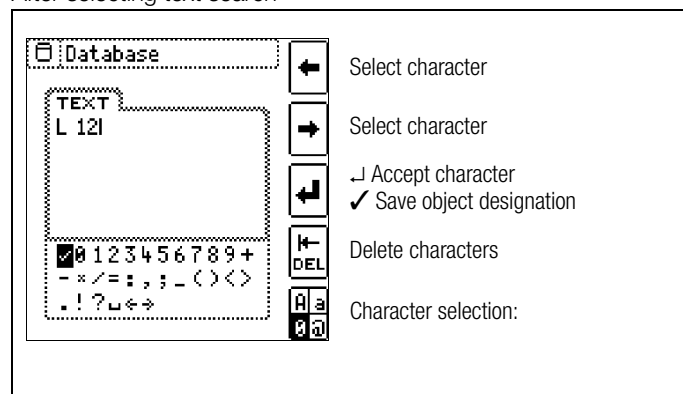

and entering the desired text (only full matches are found – no wild cards, case sensitive)

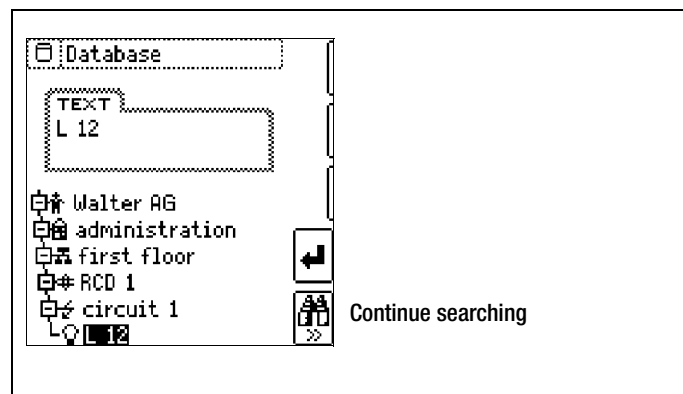

the first match is displayed.

Further matches can be found by selecting the icon shown at the right.



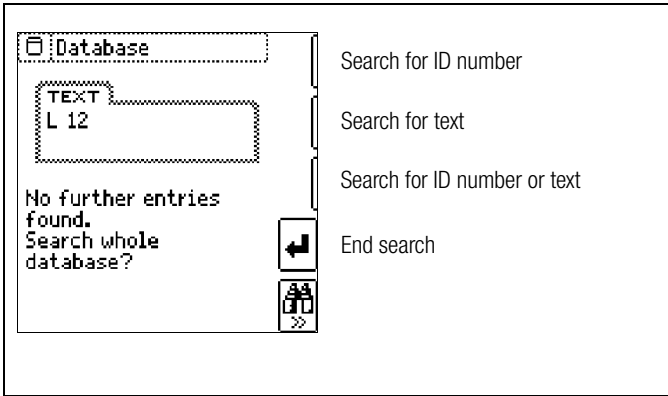

If no further matches are found, the message shown above is displayed.

16.4 Saving Data and Generating Reports

Preparing and Executing a Measurement

Measurements can be performed and stored to memory for each structural element. Proceed as follows, adhering to the prescribed sequence:

- Select the desired measurement with the rotary knob.
- Start the measurement by pressing the **ON/START** or $I_{\Delta N}$ key.

Upon completion of measurement, the "→ Floppy Disk" softkey is displayed.

- Briefly press the "Save Value" key.



The display is switched to the memory menu or the structural view.

- Navigate to the desired memory location, i.e. to the desired structural element / object, for which the measurement data will be saved.
- If you would like to save a comment along with the measurement, press the key shown at the right and enter a designation via the "EDIT" menu as described in section 16.3.1.
- Complete data storage by pressing the "STORE" key.



Storage of Error Messages (Pop-ups)

If a measurement is completed without a measured value being produced on account of an error, this measurement can be saved to memory along with the pop-up via the „Save Value“ key. In the ETC the corresponding text is given out instead of the pop-up symbol. This only applies to a limited selection of pop-ups, see below. In the database of the test instrument, neither the symbol nor the text can be retrieved.

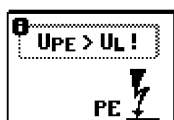
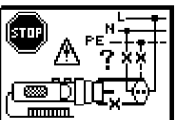
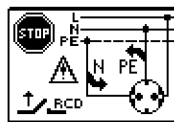
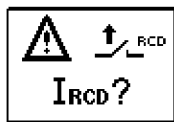
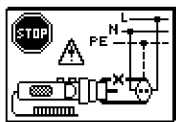

Alternative Storage Procedure

- The measured value can be saved to the last selected object in the structural diagram by **pressing and holding** the "Save Value" key, without switching the display to the memory menu.



Note

If you change the parameters in the measurement view, they are not saved for the structural element. A measurement with changed parameters can nevertheless be saved to the structural element, and any changed parameters are documented in the report for each measurement.

Retrieving Saved Measured Values

- Switch the display to the distributor structure by pressing the **MEM** key and select the desired electrical circuit with the scroll keys.
- Switch to page 2 by pressing the key shown here:
- Display the measurement data by pressing the key shown here:



One measurement with date and time, as well as any comment you might have entered, is displayed in each screen.

Example:
RCD Measurement

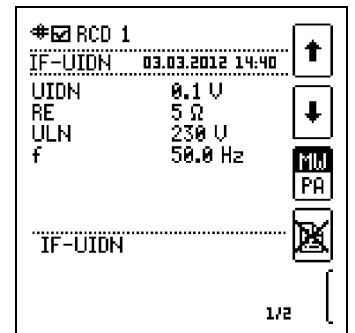

Note

A check mark in the header means that the respective measurement has been passed. An X means that the measurement has not been passed.

- Scrolling amongst measurements is possible with the keys shown here:
- The measurement can be deleted with the key shown here:



A prompt window asks you to confirm deletion.



With the help of the key shown at the right (MW: measured value / PA: parameter), the setting parameters can be displayed for this measurement.

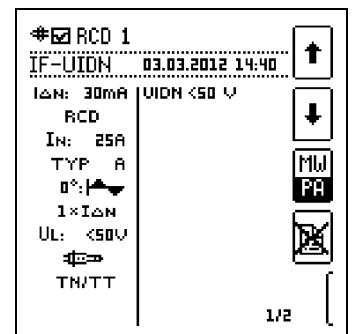

- Scrolling amongst measurements is possible with the keys shown here:

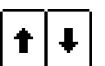

Data Evaluation and Report Generation with ETC Software

All data, including the distributor structure, can be transferred to the PC and evaluated with the help of ETC software. Additional information can be entered here subsequently for the individual measurements. After pressing the appropriate key, a report including all measurements within a given distributor structure is generated, or the data are exported to an Excel spreadsheet.



Note

The database is exited when the rotary selector switch is turned. Previously selected parameters in the database are not used for the measurement.

16.4.1 Use of Barcode Scanners and RFID Readers

Search for an Already Scanned Barcode

The search can be started from any switch setting and menu.

⇒ Scan the object's barcode.

The found barcode is displayed inversely.

⇒ This value is accepted after pressing the ENTER key.



Note

A previously selected object is not taken into consideration by the search.

Continued Searching in General



Regardless of whether or not an object has been found, searching can be continued by pressing this key:

- Object found: Searching is continued underneath the previously selected object.
- No further object found: The entire database is searched at all levels.

Reading In a Barcode for Editing

If the menu for alphanumeric entry is active, any value scanned by means of a barcode or RFID reader is accepted directly.

Using a Barcode Printer (accessory)

A barcode printer allows for the following applications:

- Read-out of ID numbers encrypted as barcodes; for quick and convenient acquisition for periodic testing
- Read-out of repeatedly occurring designations such as test object types encrypted as barcodes in a list, allowing them to be read in as required for comments.

17 Operating and Display Elements

Test Instrument and Adapter

(1) Control Panel – Display Panel

The following are displayed at the LCD:

- One or two measurement values as three place numeric display with unit of measure and abbreviated measured quantity
- Nominal values for voltage and frequency
- Circuit diagrams
- On-line help
- Messages and instructions

The display and control panel can be swiveled forward or backward with the detented swivel hinge. The instrument can thus be set to the optimum reading angle.

(2) Eyelets for the Shoulder Strap

The included shoulder strap can be attached at the right and left hand sides of the instrument. You can hang the instrument from your shoulder and keep both hands free for measurement.

(3) Rotary Selector Switch

The following basic functions can be selected with this rotary switch:

SETUP / I_{ΔN} / I_F / Z_{L-PE} / Z_{L-N} / R_E / R_{LO} / R_{ISO} (R_{INS}) / U / SENSOR / EXTRA / AUTO

The various basic functions are selected by turning the function selector switch while the instrument is switched on.

(4) Measuring Adapter



Attention!

The measuring adapter (2-pole) may only be used together with the test instrument's test plug. Use for other purposes is prohibited!

The plug-on measuring adapter (2-pole) with the two test probes is used for measurements in systems without earthing contact outlets, e.g. at permanent installations, distribution cabinets and all three-phase outlets, as well as for insulation resistance and low-value resistance measurements.

The 2-pole measuring adapter can be expanded to three poles for phase sequence testing with the included measurement cable (test probe).

(5) Plug Insert (country-specific)



Attention!

The plug insert may only be used together with the test instrument's test plug. Use for other purposes is prohibited!

After the plug insert has been attached, the instrument can be directly connected to earthing contact outlets. You need not concern yourself with poling at the plug. The instrument detects the positions of phase conductor L and neutral conductor N and automatically reverses polarity if necessary.

The instrument automatically determines whether or not both protective contacts in the earthing contact outlet are connected to one another, as well as to the system protective conductor, for all types of protective conductor measurements when the plug insert is attached to the test plug.

(6) Test Plug

The various country specific plug inserts (e.g. protective contact plug insert for Germany or SEV plug insert for Switzerland) or the measuring adapter (2-pole) are attached to the test plug and secured with a threaded connector.

The controls on the test plug are subject to interference suppression filtering. This may lead to slightly delayed responses as opposed to controls located directly on the instrument.

(7) Alligator Clip (plug-on)

(8) Test Probes

The test probes comprise the second (permanently attached) and third (plug-on) poles of the measuring adapter. A coil cable connects them to the plug-on portion of the measuring adapter.

(9) ON/Start ▼ Key



The measuring sequence for the function selected in the menu is started by pressing this key, either on the test plug or at the control panel. Exception: If the instrument is switched off, it can only be switched on by pressing the key at the control panel.

This key has the same function as the ▼ key on the test plug.

(10) I_{ΔN} / I Key (at the control panel)



The following sequences are triggered by pressing this key, either on the test plug or at the control panel:

- Starts the tripping test after measurement of contact voltage for RCCB testing (I_{ΔN}).
- Measurement of R_{OFFSET} is started within the R_{LO} / Z_{L-N} function.
- Semiautomatic polarity reversal (see section 5.8)

(11) Contact "Surfaces"

The contact surfaces are located at both sides of the test plug. When the contact plug is grasped in the hand, contact is automatically made with these surfaces. The contact surfaces are electrically isolated from the terminals and from the measuring circuit. When the rotary switch is set to the "U" position, the instrument can be used as a phase tester for protection class II devices! In the event of a potential difference of greater than 25 V between protective conductor terminal PE and the contact surface, PE is displayed (see also section 18, "LED Indications, Mains Connections and Potential Differences", beginning on page 73).

(12) Test Plug Holder

The test plug with attached plug insert can be reliably secured to the instrument with the rubberized holder.

(13) Fuses

The two fuses protect the instrument against overload. Phase conductor L and neutral conductor N are fused individually. If a fuse is defective, and if an attempt is made to perform a measurement which uses the circuit protected by this fuse, a corresponding message appears at the display panel.



Attention!

Severe damage to the instrument may occur if incorrect fuses are used. Only original fuses from GMC-I Messtechnik GmbH assure required protection by means of suitable blowing characteristics, see section 20.3.



Note

The voltage ranges remain functional even if fuses have blown.

(14) Holders for Test Probes (8)

(15/16) Current Clamp Sockets

Only the current clamp transformers offered as accessories may be connected to these sockets.

(17) Probe Connector Socket

The probe connector socket is required for the measurement of probe voltage U_{S-PE}, earth electrode voltage U_E, earthing resistance R_E and standing surface insulation resistance. It can be used for the measurement of contact voltage during RCD testing. The probe is connected with a 4 mm contact protected plug.

The instrument determines whether or not the probe has been properly set and displays results at the display panel.

(18) USB Port

The USB port allows for the exchange of data between the test instrument and a PC.

(19) RS 232 Port

This connection allows for data entry by means of a barcode scanner or an RFID reader.

(20) Charging Socket

This socket may only be used to connect the Z502R charger for recharging batteries in the instrument.

(21) Battery Compartment Lid – Replacement Fuses



Attention!

When the lid is removed, the instrument must be disconnected from the measuring circuit at all poles!

The battery compartment lid covers the Compact Master Battery Pack (Z502H) or a battery holder with the batteries and the replacement fuses.

The battery holder or the Z502H battery pack is designed for use with eight 1.5 V AA batteries in accordance with IEC LR 6 for power supply to the instrument. When inserting batteries, make sure that they are poled in accordance with the symbols.



Attention!

Make sure that all of the batteries are inserted with correct polarity. If just one battery is inserted with reversed polarity, it will not be recognized by the instrument and may result in leakage from the batteries.

Two replacement fuses are located beneath the battery compartment lid.

Control Panel – LEDs

MAINS/NETZ LED

This LED is only functional when the instrument is switched on. It has no function in voltage ranges U_{L-N} and U_{L-PE} . It lights up green, red or orange, or blinks green or red depending upon how the instrument has been connected and the selected function (see also section 18, “LED Indications, Mains Connections and Potential Differences”, beginning on page 73). This LED also lights up if line voltage is present during measurement of R_{INS} and R_{LO} .











U_L/R_L LED

This LED lights up red if contact voltage is greater than 25 V or 50 V during RCD testing, as well as after safety shut-down occurs. It also lights up if R_{INS} or R_{LO} limit values have been exceeded or fallen short of.









RCD • FI LED



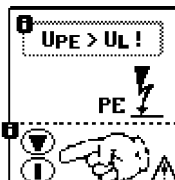

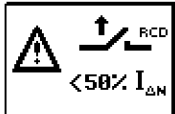

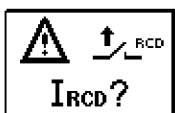

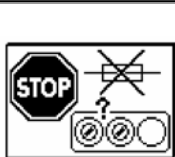
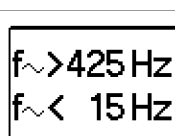

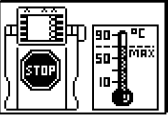

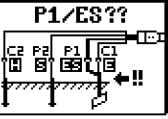
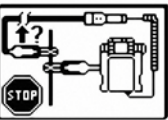
This LED lights up red if the RCCB is not tripped within 400 ms (1000 ms for type RCD S selective RCDs) during the tripping test with nominal residual current. It also lights up if the RCCB is not tripped before nominal residual current has been reached during measurement with rising residual current.

18 LED Indications, Mains Connections and Potential Differences

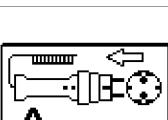
	Status	Test plug	Meas. Adapter	Position of the Function Switch	Function / Meaning
LED Indications					
NETZ/MAINS	Lights up green	X		$I_{\Delta N} / I_F \triangle$ $Z_{L-N} / Z_{L-PE} / R_E$ $\Delta U, Z_{ST}, kWh, IMD,$ int. ramp, RCM	Correct connection, measurement enabled
NETZ/MAINS	Blinks green		X	$I_{\Delta N} / I_F \triangle$ $Z_{L-N} / Z_{L-PE} / R_E$ $\Delta U, Z_{ST}, kWh, IMD,$ int. ramp, RCM	N conductor not connected, measurement enabled
NETZ/MAINS	Lights up orange		X	$I_{\Delta N} / I_F \triangle$ $Z_{L-N} / Z_{L-PE} / R_E$	Line voltage of 65 V to 253 V to PE, 2 different phases active (no N conductor at mains), measurement enabled
NETZ/MAINS	Blinks red	X	X	$I_{\Delta N} / I_F \triangle$ $Z_{L-N} / Z_{L-PE} / R_E$ $\Delta U, Z_{ST}, kWh, IMD,$ int. ramp, RCM	1) No line voltage or 2) PE interrupted
NETZ/MAINS	Lights up red		X	R_{INS} / R_{LO}	Interference voltage detected, measurement disabled
NETZ/MAINS	Blinks Yellow		X	$I_{\Delta N} / I_F \triangle$ $Z_{L-N} / Z_{L-PE} / R_E$	L and N are connected to the phase conductors.
U_L/R_L	Lights up red	X	X	$I_{\Delta N}$ R_{INS} / R_{LO}	– Contact voltage $U_{I\Delta N}$ and $U_{I\Delta} > 25 V$ respectively $> 50 V$ – Safety shut-down has occurred – Limit value exceeded or fallen short of for R_{INS} / R_{LO} function
FI/RCD	Lights up red	X	X	$I_{\Delta N} / I_F \triangle$ int. ramp	The RCCB was not tripped, or was tripped too late during the tripping test.
Mains Connection Test — Single-Phase System — LCD Connection Pictographs					
	is displayed			All except for U	No connection detected
	is displayed			All except for U	Connection OK
	is displayed			All except for U	L and N reversed, neutral conductor charged with phase voltage
	is displayed			All except for U and RE	No mains connection
	is displayed			RE	Standard display without connection messages
	is displayed			All except for U	Neutral conductor interrupted
	is displayed			All except for U	Protective conductor PE interrupted, neutral conductor N and/or phase conductor L charged with phase voltage
	is displayed			All except for U	Phase conductor L interrupted, neutral conductor N charged with phase voltage
	is displayed			All except for U	Phase conductor L and protective conductor PE reversed
	is displayed			All except for U	Phase conductor L and protective conductor PE reversed Neutral conductor interrupted (with probe only)
	is displayed			All except for U	L and N are connected to the phase conductors.

	Status	Test plug	Meas. Adapter	Position of the Function Switch	Function / Meaning
Mains Connection Test — 3-Phase System — LCD Connection Pictographs					
	is displayed			U (3-phase measurement)	Clockwise rotation
	is displayed			U (3-phase measurement)	Counter-clockwise rotation
	is displayed			U (3-phase measurement)	Short between L1 and L2
	is displayed			U (3-phase measurement)	Short between L1 and L3
	is displayed			U (3-phase measurement)	Short between L2 and L3
	is displayed			U (3-phase measurement)	Conductor L1 missing
	is displayed			U (3-phase measurement)	Conductor L2 missing
	is displayed			U (3-phase measurement)	Conductor L3 missing
	is displayed			U (3-phase measurement)	Conductor L1 to N
	is displayed			U (3-phase measurement)	Conductor L2 to N
	is displayed			U (3-phase measurement)	Conductor L3 to N
Connection Test — Earthing resistance (battery operation)					
	is displayed			RE	Standard display without connection messages
	is displayed		PRO-RE	RE	Interference voltage at probe S > 3 V Restricted measuring accuracy
	is displayed		Messzange	RE	Interference current/measuring current ratio > 50 at RE(sel), 1000 at RE(Z) Restricted measuring accuracy at RE(sel): Interference current > 0,85 A or Interference current/measuring current ratio > 100 ⇨ no measured value, display RE.Z ---
	is displayed		PRO-RE	RE	Probe H not connected or RE.H > 150 kΩ ⇨ no measurement, display RE --- RE.H > 50 kΩ or RE.H / RE > 10000 ⇨ Measured value is displayed, restricted measuring accuracy
	is displayed		PRO-RE	RE	Probe S not connected or RE.S > 150 kΩ or RE.S x RE.H > 25 MΩ² ⇨ no measurement, display RE --- RE.S > 50 kΩ or RE.S / RE > 300 ⇨ Measured value is displayed, restricted measuring accuracy
	is displayed		PRO-RE	RE	Probe E not connected or RE.E > 150 kΩ, RE.E/RE > 2000 ⇨ no measurement, display RE --- RE.E/RE > 300 ⇨ Measured value is displayed, restricted measuring accuracy

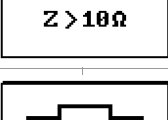

	Status	Test plug	Meas. Adapter	Position of the Function Switch	Function / Meaning
Battery Test					
	is displayed			All	Rechargeable batteries must be recharged, or replaced towards the end of their service life ($U < 8 \text{ V}$).
PE test by means of finger contact at the contact surfaces on the test plug					
LCD	LEDs				
 is displayed	U_L/R_L FI/RCD light up red	X	X	U (single-phase measurement)	Potential difference $\geq 50 \text{ V}$ between finger contact and PE (earth contact) Frequency $f \geq 50 \text{ Hz}$
 is displayed	U_L/R_L FI/RCD light up red	X	X	U (single-phase measurement)	If L is correctly contacted and PE is interrupted (Frequency $f \geq 50 \text{ Hz}$)
Error Messages — LCD Pictographs					
		X	X	All measurements with protective conductor	Potential difference $\geq U_L$ between finger contact and PE (earth contact) (Frequency $f \geq 50 \text{ Hz}$) Remedy: inspect PE connection Note: only when  appears: measurement can nevertheless be started by pressing the start key again.
		X	X	$I_{\Delta N} / I_F \triangle$ $Z_{L-N} / Z_{L-PE} / R_E$	1) Voltage too high ($U > 253 \text{ V}$) for RCD test with direct current 2) U always $U > 550 \text{ V}$ with 500 mA 3) $U > 440 \text{ V}$ for $I_{\Delta N} / I_F \triangle$ 4) $U > 253 \text{ V}$ for $I_{\Delta N} / I_F \triangle$ with 500 mA 5) $U > 253 \text{ V}$ for measurement with probe
		X	X	$I_{\Delta N}$	RCD is tripped too early, or is defective. Remedy: test circuit for bias current
		X	X	Z_{L-PE}	RCD is tripped too early, or is defective. Remedy: Test with "DC + positive half-wave".
		X	X	$I_{\Delta N} / I_F \triangle$	RCD tripped during contact voltage measurement. Remedy: Check selected nominal test current.
				EXTRA → PRCD	PRCD has tripped. Cause: poor contact or defective PRCD
		X	X	All except for U	Externally accessible fuse is blown. The voltage ranges remain functional even if fuses have blown. Special case, R_{LD}: Interference voltage during measurement may result in a blown fuse. Remedy: Replace fuse (replacement fuses in battery compartment). Observe notes regarding fuse replacement in section 20.3!
		X	X	$I_{\Delta N} / I_F \triangle$ $Z_{L-N} / Z_{L-PE} / R_E$	Frequency out of permissible range Remedy: inspect mains connection







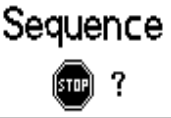
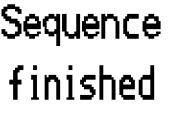

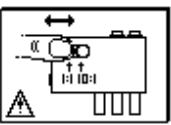
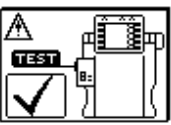
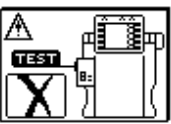
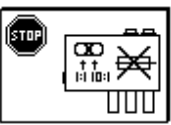













Status	Test plug	Meas. Adapter	Position of the Function Switch	Function / Meaning
			All	Excessive temperature inside the test instrument Remedy: wait for test instrument to cool down
	X	X	R _{INS} / R _{LO}	Interference voltage Remedy: device under test must be disconnected from all sources of voltage
	X	PRO-RE	RE (bat)	Interference voltage > 20 V at the probes: H to E or S to E no measurement possible
	X	PRO-RE	RE (bat)	Probe ES not connected or connected wrong.
		PRO-RE/ 2	RE (bat)	Generator current clamp (E-Clip-2) not connected
	X	X	All measurements with probe	Interference voltage at the probe
	X	X	R _{INS} / R _{LO}	Overvoltage or overloading of the measuring voltage generator during measurement of R _{INS} or R _{LO}
	X	X	I _{ΔN} / I _F Δ Z _{L-N} / Z _{L-PE} Z _{ST} , R _{ST} , R _E Meter start-up	No mains connection Remedy: inspect mains connection
	X	X	All	Defective hardware Remedy: 1) Switch on and off. or 2) Briefly remove the batteries. If error message persists, send instrument to GMC-I Service GmbH.
	X	X	R _{LO}	OFFSET measurement is not sensible. Remedy: Check system. OFFSET measurement of R _{LO} + and R _{LO} - is still possible.
		X	R _{LO}	R _{OFFSET} > 10 Ω: OFFSET measurement is not sensible. Remedy: Check system.
		X	EXTRA → ΔU	Z > 10 Ω: OFFSET measurement is not sensible. Remedy: Check system.
		X	EXTRA → ΔU	ΔU _{OFFSET} > ΔU: Offset value is larger than the measured value at the consuming system. OFFSET measurement is not sensible. Remedy: Check system.
	X	X	R _{INS} / R _{LO} / R _{E(bat)}	Contact problem or blown fuse Remedy: Check test plug or measuring adapter for correct seating in the test plug, or replace the fuse.

Status	Test plug	Meas. Adapter	Position of the Function Switch	Function / Meaning																								
		X	R_E	The polarity of the 2-pole adapter must be reversed.																								
	X		$I_{\Delta N} / I_F$	N and PE are swapped.																								
	X	X	$I_{\Delta N} / I_F$ $Z_{L-N} / Z_{L-PE} / R_E$	1) Mains connection error Remedy: Inspect mains connection. or 2) Display in the connection pictograph: PE interrupted (x) or underlying protective conductor bar interrupted with reference to the keys at the test plug Cause: voltage measuring path interrupted Result: measurement is disabled Note: only if appears: Measurement can nevertheless be started by pressing the start key again.																								
	X		$I_{\Delta N} / I_F$	Display at the connection pictograph: Overlying protective conductor bar interrupted with reference to the keys at the test plug Cause: current measuring path interrupted Result: no measured value display																								
			R_E $I_{\Delta N} / I_F$	Probe is not detected, probe not connected Remedy: inspect probe connection																								
			R_E	Clamp is not detected: – Clamp is not connected or – Current through clamp is too small (partial earth resistance too high) or – Transformation ratio set incorrectly Remedy: Check clamp connection and transformation ratio. Check the batteries in the METRAFLEX P300 and replace if necessary.																								
			R_E	If you have changed the transformation ratio at the test instrument, a message appears prompting you to change the setting at the current clamp sensor as well.																								
			R_E	Voltage too high at clamp input or signal distorted The transformation ratio parameter selected at the test instrument might not correspond to the transformation ratio at the current clamp sensor. Remedy: Check transformation ratio or setup.																								
			All	Battery voltage is less than or equal to 8 V. Reliable measurement is no longer possible. Storage of measured values to memory is disabled. Remedy: Rechargeable batteries must be recharged, or replaced towards the end of their service life.																								
			$I_{\Delta N} / I_F$	Resistance in N-PE path is too high. <table border="1" data-bbox="758 1657 1508 1780"> <thead> <tr> <th></th> <th colspan="5">$I_{\Delta N} / I_F$</th> </tr> <tr> <th></th> <th>10 mA</th> <th>30 mA</th> <th>100 mA</th> <th>300 mA</th> <th>500 mA</th> </tr> </thead> <tbody> <tr> <td>R_{MAX} for $I_{\Delta N}$</td> <td>510 Ω</td> <td>170 Ω</td> <td>50 Ω</td> <td>15 Ω</td> <td>9 Ω</td> </tr> <tr> <td>R_{MAX} for I_F</td> <td>410 Ω</td> <td>140 Ω</td> <td>40 Ω</td> <td>12 Ω</td> <td>7 Ω</td> </tr> </tbody> </table> Consequence: Required test current cannot be generated, measurement is aborted.		$I_{\Delta N} / I_F$						10 mA	30 mA	100 mA	300 mA	500 mA	R_{MAX} for $I_{\Delta N}$	510 Ω	170 Ω	50 Ω	15 Ω	9 Ω	R_{MAX} for I_F	410 Ω	140 Ω	40 Ω	12 Ω	7 Ω
	$I_{\Delta N} / I_F$																											
	10 mA	30 mA	100 mA	300 mA	500 mA																							
R_{MAX} for $I_{\Delta N}$	510 Ω	170 Ω	50 Ω	15 Ω	9 Ω																							
R_{MAX} for I_F	410 Ω	140 Ω	40 Ω	12 Ω	7 Ω																							
			Z_{L-PE}, R_E	Upon exceeding the specified contact voltage U_L : Z_{L-PE} and R_E : request to switch to the 15 mA wave only R_E alternatively: Request to reduce the measuring range (reduce current)																								

Status	Test plug	Meas. Adapter	Position of the Function Switch	Function / Meaning
Entry Plausibility Check – Parameters Combination Checking — LCD Pictographs				
				Parameter out of range
			$I_{\Delta N} / I_F \triangle$	5 x 500 mA is not possible
			$I_{\Delta N} / I_F \triangle$	Type B, B+ and EV/MI not possible with G/R, SRCD and PRCD
			$I_{\Delta N}$	180° not possible for G/R, SRCD, PRCD
			$I_{\Delta N} / I_F \triangle$	DC not possible with G/R, SRCD, PRCD
			$I_{\Delta N} / I_F \triangle$	Half-wave or DC not possible with type AC, F, B+ and EV/MI
			$I_{\Delta N} / I_F \triangle$ EXTRA → RCM	DC not possible with type A
			$I_{\Delta N}$	1/2 test current not possible with DC
			$I_{\Delta N}$	2 x / 5 x IdN with full-wave only
			R_E	Not without probe in IT network!
			R_E	Battery powered measurement not possible, e.g. with 4-pole adapter connected to the test plug, or for 2-clamp measurement of measurement of soil resistivity
			R_E	Mains powered measurement not possible, e.g. with 2/3-pole adapter connected to the test plug
			$I_{\Delta N} / I_F \triangle$	DC+ with 10 Ω only
			R_E	No DC bias magnetization in the IT network

Status	Test plug	Meas. Adapter	Position of the Function Switch	Function / Meaning
			R _E	15 mA only possible in the 1 kΩ and 100 Ω range!
			R _E	15 mA only as loop measurement with or without probe
			EXTRA → RCM	With RCM: TYPE AC, F , B, B+ and EV/MI not possible
			I _{ΔN} / I _F	No measurement with half-wave or DC in the IT network
			All	The parameters you have selected do not make sense in combination with previously configured parameters. The selected parameter settings will not be saved. Remedy: Enter other parameter settings.
			R _E	2 pole measurement via earthing contact plug (not possible in IT systems)
			EXTRA → ta+IΔ	The intelligent ramp is not possible with RCD types RCD-S and G/R.

Status	Test plug	Meas. Adapter	Position of the Function Switch	Function / Meaning
Messages — LCD Pictographs — Test sequences				
			AUTO	The test sequence includes a measurement which cannot be processed by the connected test instrument. The respective test step must be skipped. Example: The test sequence includes a RCM measurement which has been transferred to PROFITEST MTECH.
			AUTO	The test sequence has been successfully completed.
			AUTO	There are no test sequences available. Cause: They may have been deleted by the following operations: Changing of language, profile, DB mode or by resetting the test instrument to default values.
Error Messages — LCD Pictographs — PRO-AB Leakage Current Adapter				
			EXTRA → I _L	Measuring range exceeded Change into the bigger measuring range (test instrument and leakage current measuring adapter).
			EXTRA → I _L	Test measurement: The test has been passed successfully. The leakage current measuring adapter is now ready for use.
			EXTRA → I _L	Test measurement: The test has failed. The leakage current measuring adapter is defective. Please consult our repair service.
			EXTRA → I _L	Test measurement: Check the fuse in the leakage current measuring adapter.

Status	Test plug	Meas. Adapter	Position of the Function Switch	Function / Meaning
Database and Entry Operations — LCD Pictographs				
			$I_{\Delta N} / I_F$ Z_{L-N} / Z_{L-PE} EXTRA → $t_A + I_{\Delta}$ EXTRA → RCM	Saving a measured value with differing electrical circuit parameter The electrical circuit parameter you have set at the test instrument does not correspond to the parameter saved in the structure under object data. Example: The residual operating current defined in the database is 10 mA, whereas you have performed measurements with 100 mA. If you wish to perform all future measurements with 100 mA, the value must be modified in the database by acknowledging it with <input checked="" type="checkbox"/> . The measured value will be documented and the new parameter will be accepted. If you wish to leave the parameter in the database unchanged, press key <input type="checkbox"/> . Measured value and modified parameter will only be documented.
			All	TXT = ? Abc...123 ! Please enter a designation (alphanumeric).
			All	Operation with a Barcode Scanner Error message appears when the "EDIT" entry field is opened and battery voltage is less than 8 V. Output voltage is generally switched off during barcode scanner operation if U is less than 8 V in order to assure that remaining battery capacity is adequate for entering designations for devices under test and saving the measurement. Remedy: Rechargeable batteries must be recharged, or replaced towards the end of their service life.
			All	Operation with a Barcode Scanner Current flowing through the RS 232 port is too high. Remedy: The connected device is not suitable for this port.
			All	Operation with a Barcode Scanner Barcode not recognized, incorrect syntax
			All	Data cannot be entered at this location within the structure. Remedy: Observe profile for preselected PC software (see SETUP menu).
			All	Measured value cannot be saved at this location within the structure. Remedy: Make sure that you have selected the right profile for you PC evaluation program in the SETUP menu (see section 4.6).
			All	Memory is full. Remedy: Save your measurement data to a PC and then clear memory at test instrument by deleting the database or by importing an empty database.
			All	Delete measurement or database. This prompt window asks you to confirm deletion.
			SETUP	Data loss after changing language or profile, or after restoring default settings. Back up your measurement data to a PC before pressing the respective key. This prompt window asks you to confirm deletion.
			All	This error message appears when the database, i. e. the structure created in the ETC software, is too large for the device memory. The database in the device memory is empty after database transfer has been interrupted. Remedy: Reduce the database in ETC or send the database without measured values (key Send structure) if measured values should already be available.

19 Characteristic Values

Characteristic Values MBASE+ & MTECH+

Function	Measured Quantity	Display Range	Resolution	Input Impedance/ Test Current	Measuring Range	Nominal Values	Measuring Uncertainty	Intrinsic Uncertainty	Connections						
									Plug Insert 1	2-Pole Adapter	3-Pole Adapter	Probe	Clamps WZ12C Z3512A MFLX P300		
U	U_{L-PE} U_{N-PE}	0 ... 99.9 V 100 ... 600 V	0.1 V 1 V	5 MΩ	0.3 ... 600 V ¹⁾	$U_N = 120/230/400/500 V$ $f_N = 16^{2/3}/3/50/60/200/400 Hz$	±(2% rdg.+5d) ±(2% rdg.+1d)	±(1% rdg.+5d) ±(1% rdg.+1d)	●	●	●				
	f	15.0 ... 99.9 Hz 100 ... 999 Hz	0.1 Hz 1 Hz		DC 15,4 ... 420 Hz		±(0.2% rdg.+1d)	±(0.1% rdg.+1d)							
	U_{3-}	0 ... 99.9 V 100 ... 600 V	0.1 V 1 V		0.3 ... 600 V		±(3% rdg.+5d) ±(3% rdg.+1d)	±(2% rdg.+5d) ±(2% rdg.+1d)		●					
	U_{PROBE}	0 ... 99.9 V 100 ... 600 V	0.1 V 1 V		1.0 ... 600 V		±(2% rdg.+5d) ±(2% rdg.+1d)	±(1% rdg.+5d) ±(1% rdg.+1d)			●				
	U_{L-N}	0 ... 99.9 V 100 ... 600 V	0.1 V 1 V		1.0 ... 600 V ¹⁾		±(3% rdg.+5d) ±(3% rdg.+1d)	±(2% rdg.+5d) ±(2% rdg.+1d)	●		●				
$I_{\Delta N}$ I_F	$U_{\Delta N}$	0 ... 70.0 V	0.1 V	$0.3 \cdot I_{\Delta N}$	5 ... 70 V	$U_N = 120 V$ $230 V$ $400 V^2$ $f_N = 50/60 Hz$ $U_L = 25/50 V$ $I_{\Delta N} = 6 mA$ $10 mA$ $30 mA$ $100 mA$ $300 mA$ $500 mA^2$	+10% rdg.+1d	+1% rdg.-1d ... +9% rdg.+1d							
	R_E	10 Ω ... 999 Ω 1.00 kΩ ... 6.51 kΩ	1 Ω 0.01 kΩ	calculated value from $U_{\Delta N} / I_{\Delta N}$	$I_{\Delta N} = 10 mA \cdot 1.05$		±(5% rdg.+1d)	±(3.5% rdg.+2d)	optional	●					
		3 Ω ... 999 Ω 1 kΩ ... 2.17 kΩ	1 Ω 0.01 kΩ		$I_{\Delta N} = 30 mA \cdot 1.05$										
		1 Ω ... 651 Ω	1 Ω		$I_{\Delta N} = 100 mA \cdot 1.05$										
		0.3 Ω ... 99.9 Ω 100 Ω ... 217 Ω	0.1 Ω 1 Ω		$I_{\Delta N} = 300 mA \cdot 1.05$										
		0.2 Ω ... 9.9 Ω 10 Ω ... 130 Ω	0.1 Ω 1 Ω		$I_{\Delta N} = 500 mA \cdot 1.05$										
	$I_F (I_{\Delta N} = 6 mA)$	1.8 ... 7.8 mA		1.8 ... 7.8 mA	1.8 ... 7.8 mA										
	$I_F (I_{\Delta N} = 10 mA)$	3.0 ... 13.0 mA	0,1 mA	3.0 ... 13.0 mA	3.0 ... 13.0 mA										
	$I_F (I_{\Delta N} = 30 mA)$	9.0 ... 39.0 mA		9.0 ... 39.0 mA	9.0 ... 39.0 mA										
	$I_F (I_{\Delta N} = 100 mA)$	30 ... 130 mA	1 mA	30 ... 130 mA	30 ... 130 mA										
	$I_F (I_{\Delta N} = 300 mA)$	90 ... 390 mA	1 mA	90 ... 390 mA	90 ... 390 mA										
	$I_F (I_{\Delta N} = 500 mA)$	150 ... 650 mA	1 mA	150 ... 650 mA	150 ... 650 mA										
$U_{\Delta L} / U_L = 25 V$	0 ... 25.0 V	0.1 V	wie I_{Δ}	0 ... 25.0 V	+10% rdg.+1d	+1% rdg.-1d ... +9% rdg.+1 d									
$U_{\Delta L} / U_L = 50 V$	0 ... 50.0 V			0 ... 50.0 V											
$t_A (I_{\Delta N} \cdot 1)$	0 ... 1000 ms	1 ms	6 ... 500 mA	0 ... 1000 ms											
$t_A (I_{\Delta N} \cdot 2)$	0 ... 1000 ms		2 · 6 ... 2 · 500 mA	0 ... 1000 ms	±4 ms	±3 ms									
$t_A (I_{\Delta N} \cdot 5)$	0 ... 40 ms	1 ms	5 · 6 ... 5 · 300 mA	0 ... 40 ms											
Z_{L-PE} Z_{L-N}	Z_{L-PE} (⚡) Z_{L-N}	0 ... 999 mΩ 1.00 ... 9.99 Ω	1 mΩ 0.01 Ω	1.3 ... 3.7 A AC 0.5/1.25 A DC	0.15 ... 0.49 Ω 0.50 ... 0.99 Ω 1.00 ... 9.99 Ω	$U_N = 120/230 V$ $400/500 V^1$ $f_N = 16^{2/3}/3/50/60 Hz$	±(10% rdg.+30d) ±(10% rdg.+30d) ±(5% rdg.+3d)	±(5% rdg.+30d) ±(4% rdg.+30d) ±(3% rdg.+3d)							
	Z_{L-PE} (⚡) + DC	0 ... 999 mΩ 1.00 ... 9.99 Ω 10.0 ... 29.9 Ω	0.1 Ω		0.25 ... 0.99 Ω 1.00 ... 9.99 Ω		$U_N = 120/230 V$ $f_N = 50/60 Hz$	±(18% rdg.+30d) ±(10% rdg.+3d)	±(6% rdg.+50d) ±(4% rdg.+3d)						
	$I_K (Z_{L-PE}$ ⚡)	0 ... 9.9 A 10 ... 999 A	0,1 A 1 A		120 (108 ... 132) V 230 (196 ... 253) V 400 (340 ... 440) V 500 (450 ... 550) V		calculated value from Z_{L-PE}	●	●	Z_{L-PE}					
	Z_{L-PE} (⚡) + DC)	1.00 ... 9.99 kA 10.0 ... 50.0 kA	10 A 100 A												
	Z_{L-PE} (15 mA)	0.5 ... 9.99 Ω	0.01 Ω		only display range										
	R_E	R_E (with probe)	0 ... 999 mΩ 1.00 ... 9.99 Ω		1 mΩ 0.01 Ω		1.3 ... 3.7 A AC 0.5/1.25 A DC	0.15 Ω ... 0.49 Ω 0.50 Ω ... 0.99 Ω	$U_N = 120/230 V$ $U_N = 400 V^1$ $f_N = 50/60 Hz$	±(10% rdg.+30d) ±(10% rdg.+30d)	±(5% rdg.+30d) ±(4% rdg.+30d)				
R_E (without probe) values as Z_{L-PE}		10.0 ... 99.9 Ω 100 ... 999 Ω 1 kΩ ... 9.99 kΩ	0,1 Ω 1 Ω 0.01 kΩ	1.0 Ω ... 9.99 Ω 10 Ω ... 99.9 Ω 100 Ω ... 999 Ω 1 kΩ ... 9.99 kΩ	±(5% rdg.+3d) ±(10% rdg.+3d) ±(10% rdg.+3d) ±(10% rdg.+3d)	±(3% rdg.+3d) ±(3% rdg.+3d) ±(3% rdg.+3d) ±(3% rdg.+3d)									
R_E DC+ (⚡)		0 ... 999 mΩ 1.00 ... 9.99 Ω 10.0 ... 29.9 Ω	1 mΩ 0.01 Ω 0.1 Ω	0.25 ... 0.99 Ω 1.00 ... 9.99 Ω	$U_N = 120/230 V$ $f_N = 50/60 Hz$	±(18% rdg.+30d) ±(10% rdg.+3d)		±(6% rdg.+50D) ±(4% rdg.+3D)							
U_E	0 ... 253 V	1 V	—	calculated value											
R_E Sel clip	R_E	0 ... 999 Ω	1 mΩ ... 1 Ω	1.3 ... 3.7 A AC 0.5/1.25 A DC	0.25 ... 300 Ω ⁵⁾	see R_E $U_N = 120/230 V$ $f_N = 50/60 Hz$	±(20% rdg.+20 d)	±(15% rdg.+20 d)				●	●		
	R_E DC+ (⚡)	0 ... 999 Ω	1 mΩ ... 1 Ω		±(22% rdg.+20 d)		±(15% rdg.+20 d)								
EX-TRA	Z_{ST}	0 ... 30 MΩ	1 kΩ	2.3 mA at 230 V	10 kΩ ... 199 kΩ 200 kΩ ... 30 MΩ	$U_0 = U_{L-N}$	±(20% rdg.+2d) ±(10% rdg.+2d)	±(10% rdg.+3d) ±(5% rdg.+3d)	●	●	●	●			

Function	Measured Quantity	Display Range	Resolution	Test Current	Measuring Range	Nominal Values	Measuring Uncertainty	Intrinsic Uncertainty	Connections						
									Plug Insert ¹	2-Pole Adapter	3-Pole Adapter	Clamps			
									WZ12C	Z3512A	MFLEX P300	CP1100			
R_{INS}	R _{INS} , R _{EINS}	1 ... 999 kΩ	1 kΩ	I _k = 1.5 mA	50 kΩ ... 500 MΩ	U _N = 50 V I _N = 1 mA	kΩ range ±(5% rdg.+10d)	kΩ range ±(3% rdg.+10d)	●	●					
		1.00 ... 9.99 MΩ	10 kΩ			U _N = 100 V I _N = 1 mA									
		10.0 ... 99.9 MΩ	100 kΩ			U _N = 250 V I _N = 1 mA									
		1 ... 999 kΩ	1 kΩ			U _N = 500 V / 1000 V I _N = 1 mA									
	U	10 ... 999 V 1.00 ... 1.19 kV	1 V 10 V		10 ... 1.19 kV		±(3% rdg.+1d)	±(1.5% rdg.+1d)							
R_{LO}	R _{LO}	0.01 Ω ... 9.99 Ω 10.0 Ω ... 99.9 Ω	10 mΩ 100 mΩ	I _m ≥ 200 mA I _m < 200 mA	0.1 Ω ... 5.99 Ω 6.0 Ω ... 100 Ω	U ₀ = 4.5 V	±(4% rdg.+2d)	±(2% rdg.+2d)		●					
				Transformation ratio³			5	5							
SEN- SOR 6 7	I _{L/Amp}	0.0 ... 99.9 mA	0.1 mA	1 V/A	5 ... 15 A	f _N = 50/60 Hz	±(13% rdg.+5d)	±(5% rdg.+4d)							
		100 ... 999 mA	1 mA				±(13% rdg.+1d)	±(5% rdg.+1d)							
		1.00 ... 9.99 A	0.01 A				±(11% rdg.+4d)	±(4% rdg.+3d)							
		10.0 ... 15.0 A	0.1 A				±(11% rdg.+1d)	±(4% rdg.+1d)							
		1.00 ... 9.99 A	0.01 A	1 mV/A	5 ... 150 A	f _N = 16.7/50/60/ 200/400 Hz	±(7% rdg.+2 d)	±(5% rdg.+2 d)							
		10.0 ... 99.9 A	0.1 A				±(7% rdg.+1 d)	±(5% rdg.+1 d)							
		100 ... 999 A	1 A				±(3.4% rdg.+2 d)	±(3% rdg.+2 d)							
		0.00 ... 9.99 A	0.01 A				±(3.1% rdg.+2 d)	±(3% rdg.+2 d)							
		0.00 ... 9.99 A	0.1 A	±(3.1% rdg.+1 d)	±(3% rdg.+1 d)										
		10.0 ... 99.9 A	0.1 A	±(3.1% rdg.+1 d)	±(3% rdg.+1 d)										
		100 ... 999 A	1 A	±(3.1% rdg.+2 d)	±(3% rdg.+2 d)										
		0.00 ... 9.99 A	0.01 A	±(3.1% rdg.+1 d)	±(3% rdg.+1 d)										
		0.0 ... 99.9 mA	0.1 mA	1 V/A	30 ... 1000 mA	f _N = 50/60 Hz	±(27% rdg.+100 d)	±(3% rdg.+100 d)							
		100 ... 999 mA	1 mA				±(27% rdg.+11 d)	±(3% rdg.+11 d)							
		0.00 ... 9.99 A	0.01 A				±(27% rdg.+12 d)	±(3% rdg.+12 d)							
		10.0 ... 99.9 A	0.1 A				±(27% rdg.+11 d)	±(3% rdg.+11 d)							
0.00 ... 9.99 A	0.01 A	10 mV/A	3 ... 100 A	f _N = 50/60 Hz	±(27% rdg.+100 d)	±(3% rdg.+100 d)									
10.0 ... 99.9 A	0.1 A				±(27% rdg.+11 d)	±(3% rdg.+11 d)									
0.00 ... 9.99 A	0.01 A				±(5% rdg.+12 d)	±(3% rdg.+12 d)									
10.0 ... 99.9 A	0.1 A				±(5% rdg.+2 d)	±(3% rdg.+2 d)									
0.00 ... 9.99 A	0.01 A	10 mV/A	0.5 ... 100 A	f _N = DC/16.7/50/60/ 200 Hz	±(5% rdg.+50 d)	±(3% rdg.+50 d)									
10.0 ... 99.9 A	0.1 A				±(5% rdg.+7 d)	±(3% rdg.+7 d)									
0.00 ... 9.99 A	0.01 A				±(5% rdg.+2 d)	±(3% rdg.+2 d)									
10.0 ... 99.9 A	0.1 A				±(5% rdg.+2 d)	±(3% rdg.+2 d)									

1 U > 253 V, with 2 or 3-pole adapter only
2 1/2 · IΔN > 300 mA and 5 · IΔN > 500 mA and I_f > 300 mA only up to U_N ≤ 230 V!
IΔN 5 · 300 mA only with U_N = 230 V
3 The transformation ratio selected at the clamp (1 ... 1000 mV/A) must be set in the "Type" menu with the rotary switch in the "SENSOR" position.
4 at R_{Eselektiv}/R_{Egesamt} < 100
5 the indicated measuring and intrinsic uncertainties already include the uncertainties of the respective current clamp.
6 Measuring range of the signal input at the test instrument U_E: 0 ... 1.0 V_{eff} (0 ... 1.4 V_{peak}) AC/DC
7 Input impedance of signal input at the test instrument: 800 kΩ
8 for f_N < 45 Hz => U_N < 253 V

Key: D = digits, rdg. = measured value (reading)

Characteristic Values MPRO, MXTRA & SECULIFE IP

Function	Measured Quantity	Display Range	Resolution	Input Impedance / Test Current	Measuring Range	Nominal Values	Measuring Uncertainty	Intrinsic Uncertainty	Connections					Clamp	WZ12C	Z3512A	MFLEX P300
									Plug Insert 1	2-Pole Adapter	3-Pole Adapter	Probe					
U	U _{L-PE} U _{N-PE}	0 ... 99.9 V 100 ... 600 V	0.1 V 1 V	5 MΩ	0.3 ... 600 V ¹	U _N = 120 V 230 V 400 V 500 V	±(2% rdg.+5d) ±(2% rdg. + 1 d)	±(1% rdg.+5d) ±(1% rdg. + 1 d)	●	●	●	●					
	f	15.0 ... 99.9 Hz 100 ... 999 Hz	0.1 Hz 1 Hz		DC 15.4 ... 420 Hz		±(0.2% rdg. + 1 d)	±(0.1% rdg. + 1 d)									
	U ₃₋	0 ... 99.9 V 100 ... 600 V	0.1 V 1 V		0.3 ... 600 V		±(3% rdg.+5d) ±(3% rdg. + 1 d)	±(2% rdg.+5d) ±(2% rdg. + 1 d)									
	U _{Probe}	0 ... 99.9 V 100 ... 600 V	0.1 V 1 V		1.0 ... 600 V		±(2% rdg.+5d) ±(2% rdg. + 1 d)	±(1% rdg.+5d) ±(1% rdg. + 1 d)									
	U _{L-N}	0 ... 99.9 V 100 ... 600 V	0.1 V 1 V		1.0 ... 600 V ¹		±(3% rdg.+5d) ±(3% rdg. + 1 d)	±(2% rdg.+5d) ±(2% rdg. + 1 d)									
I _{ΔN}	U _{IΔN}	0 ... 70.0 V	0.1 V	0.3 · I _{ΔN}	5 ... 70 V	U _N = 120 V 230 V 400 V f _N = 50/60 Hz U _L = 25/50 V I _{ΔN} = 6 mA 10 mA 30 mA 100 mA 300 mA 500 mA ² U _N ≤ 230 V U _N ≤ 230 V	+10% rdg. + 1 d	+1% rdg. -1d +9% rdg. + 1 d	●	●	●	Option					
	R _E	10 Ω ... 999 Ω 1.00 kΩ ... 6.51 kΩ	1 Ω 0.01 kΩ	I _{ΔN} = 10 mA · 1.05	calculated value Off R _E = U _{IΔN} / I _{ΔN}												
		3 Ω ... 999 Ω 1 kΩ ... 2.17 kΩ	1 Ω 0.01 kΩ	I _{ΔN} = 30 mA · 1.05													
		1 Ω ... 651 Ω	1 Ω	I _{ΔN} = 100 mA · 1.05													
		0.3 Ω ... 99.9 Ω 100 Ω ... 217 Ω	0.1 Ω 1 Ω	I _{ΔN} = 300 mA · 1.05													
		0.2 Ω ... 9.9 Ω 10 Ω ... 130 Ω	0.1 Ω 1 Ω	I _{ΔN} = 500 mA · 1.05													
	I _F (I _{ΔN} = 6 mA)	1.8 ... 7.8 mA		1.8 ... 7.8 mA	1.8 ... 7.8 mA												
	I _F (I _{ΔN} = 10 mA)	3.0 ... 13.0 mA	0.1 mA	3.0 ... 13.0 mA	3.0 ... 13.0 mA												
	I _F (I _{ΔN} = 30 mA)	9.0 ... 39.0 mA		9.0 ... 39.0 mA	9.0 ... 39.0 mA												
	I _F (I _{ΔN} = 100 mA)	30 ... 130 mA	1 mA	30 ... 130 mA	30 ... 130 mA			±(5% rdg. + 1 d)								±(3.5% rdg. + 2 d)	
	I _F (I _{ΔN} = 300 mA)	90 ... 390 mA	1 mA	90 ... 390 mA	90 ... 390 mA												
	I _F (I _{ΔN} = 500 mA)	150 ... 650 mA	1 mA	150 ... 650 mA	150 ... 650 mA												
	U _{IΔ} / U _L = 25 V	0 ... 25.0 V	0.1 V	Same as I _Δ	0 ... 25.0 V			+10% rdg. + 1 d								+1% rdg. -1d +9% rdg. + 1 d	
U _{IΔ} / U _L = 50 V	0 ... 50.0 V			0 ... 50.0 V													
t _A (I _{ΔN} · 1)	0 ... 1000 ms	1 ms	6 ... 500 mA	0 ... 1000 ms													
t _A (I _{ΔN} · 2)	0 ... 1000 ms	1 ms	2 · 6 ... 2 · 500 mA	0 ... 1000 ms		±4 ms	±3 ms										
t _A (I _{ΔN} · 5)	0 ... 40 ms	1 ms	5 · 6 ... 5 · 300 mA	0 ... 40 ms													
Z _{L-PE} Z _{L-N}	Z _{L-PE} (AC) Z _{L-N}	0 ... 999 mΩ 1.00 ... 9.99 Ω	1 mΩ 0.01 Ω	3.7 ... 4.7 A AC	0.10 ... 0.49 Ω 0.50 ... 0.99 Ω 1.00 ... 9.99 Ω	U _N = 120/230 V 400/500 V ¹ f _N = 16 ² /3 ⁸ /50/60 Hz	±(10% rdg.+20d) ±(10% rdg.+20d) ±(5% rdg.+3d)	±(5% rdg.+20d) ±(4% rdg.+20d) ±(3% rdg.+3d)	●	●	●						
	Z _{L-PE} (AC) + DC	0 ... 999 mΩ 1.00 ... 9.99 Ω 10.0 ... 29.9 Ω	0.1 Ω	3.7 ... 4.7 A AC 0.5/1.25 A DC	0.25 ... 0.99 Ω 1.00 ... 9.99 Ω	U _N = 120/230 V f _N = 50/60 Hz	±(18% rdg.+30d) ±(10% rdg.+3d)	±(6% rdg.+50d) ±(4% rdg.+3d)									
	I _K (Z _{L-PE})	0 ... 9.9 A 10 ... 999 A	0.1 A 1 A		120 (108 ... 132) V 230 (196 ... 253) V 400 (340 ... 440) V 500 (450 ... 550) V		Value calculated from Z _{L-PE}										
	Z _{L-PE} (15 mA)	0.5 ... 99.9 Ω 100 ... 999 Ω	0.1 Ω 1 Ω		10 ... 100 Ω 100 ... 1000 Ω	U _N = 120/230 V f _N = 16 ² /3 ⁸ /50/60 Hz	±(10% rdg.+10d) ±(8% rdg. + 2 d)	±(2% rdg. + 2 d) ±(1% rdg. + 1 d)									
	I _K (15 mA)	0.10 ... 9.99 A 10.0 ... 99.9 A 100 ... 999 A ¹⁴⁾	0.01 A 0.1 A 1 A	15 mA AC	100 mA ... 12 A (U _N = 120 V) 200 mA ... 25 A (U _N = 230 V)		Value calculated from I _K = U _N /Z _{L-PE} (15 mA)										
R _E	R _{E,sl} (without probe)	0 ... 999 mΩ 1.00 ... 9.99 Ω 10.0 ... 99.9 Ω	1 mΩ 0.01 Ω 0.1 Ω	3.7 ... 4.7 A AC 400 mA AC 40 mA AC 4 mA AC	0.10 Ω ... 0.49 Ω 0.50 Ω ... 0.99 Ω 1.0 Ω ... 9.99 Ω	U _N same as U function ¹ f _N = 50/60 Hz	±(10% rdg.+20d) ±(10% rdg.+20d) ±(5% rdg.+3d)	±(5% rdg.+20d) ±(4% rdg.+20d) ±(3% rdg.+3d)	●	●	●						
	R _E (with probe)	100 ... 999 Ω 1 kΩ ... 9.99 kΩ	1 Ω 0.01 kΩ		100 Ω ... 999 Ω 1 kΩ ... 9.99 kΩ		±(10% rdg.+3d) ±(10% rdg.+3d)	±(3% rdg.+3d) ±(3% rdg.+3d)									
	R _E (15 mA) (without/with probe)	0.5 ... 99.9 Ω 100 ... 999 Ω	0.1 Ω 1 Ω	15 mA AC	10 Ω ... 99.9 Ω 100 Ω ... 999 Ω	U _N = 120/230 V f _N = 50/60 Hz	±(10% rdg.+10d) ±(8% rdg. + 2 d)	±(2% rdg. + 2 d) ±(1% rdg. + 1 d)									
	R _{E,sl} (without probe) + DC R _{E,sl} (with probe) + DC	0 ... 999 mΩ 1.00 ... 9.99 Ω 10.0 ... 29.9 Ω	1 mΩ 0.01 Ω 0.1 Ω	3.7 ... 4.7 A AC 0.5/1.25 A DC	0.25 ... 0.99 Ω 1.00 ... 9.99 Ω	U _N = 120/230 V f _N = 50/60 Hz	±(18% rdg.+30d) ±(10% rdg.+3d)	±(6% rdg.+50d) ±(4% rdg.+3d)									
	U _E	0 ... 253 V	1 V	3.7 ... 4.7 A AC	R _E = 0.10 ... 9.99 Ω	U _N = 120/230 V f _N = 50/60 Hz	Calculated U _E = U _N · R _E /R _{E,sl}										
R _E Sel Clamp	R _{E,sel} (only with probe)	0 ... 999 mΩ 1.00 ... 9.99 Ω 10.0 ... 99.9 Ω 100 ... 999 Ω	1 mΩ 0.01 Ω 0.1 Ω 1 Ω	2.1 A AC 2.1 A AC 400 mA AC 40 mA AC	0.25 ... 300 Ω ⁴	U _N = 120/230 V f _N = 50/60 Hz	±(20% rdg.+20 d)	±(15% rdg.+20 d)	●	●	●						
	R _{E,sel} (only with probe) + DC	0 ... 999 mΩ 1.00 ... 9.99 Ω 10.0 ... 99.9 Ω 100 ... 999 Ω	1 mΩ 0.01 Ω 0.1 Ω 1 Ω	3.7 ... 4.7 A AC 0.5/1.25 A DC	0.25 ... 300 Ω R _{E,tot} < 10 Ω ⁴	U _N = 120/230 V f _N = 50/60 Hz	±(22% rdg.+20 d)	±(15% rdg.+20 d)									
EXTRA	Z _{ST}	0 to 30 MΩ	1 kΩ	2.3 mA at 230 V	10 kΩ ... 199 kΩ 200 kΩ ... 30 MΩ	U ₀ = U _{L-N}	±(20% rdg. + 2 d) ±(10% rdg. + 2 d)	±(10% rdg.+3 d) ±(5% rdg.+3 d)	●	●	●	●					
EXTRA	IMD test	20 ... 648 kΩ 2.51 MΩ	1 kΩ 0.01 MΩ	IT line voltage U _{it} = 90 ... 550 V	20 kΩ ... 199 kΩ 200 kΩ ... 648 kΩ 2.51 MΩ	IT system nominal voltages U _{N,it} = 120/230/400/ 500 V f _N = 50/60 Hz	±7% ±12% ±3%	±5% ±10% ±2%	●	●	●	●					

Function	Measured Quantity	Display Range	Resolution	Test Current	Measuring Range	Nominal Values	Measuring Uncertainty	Intrinsic Uncertainty	Connections								
									Plug Insert 1	2-Pole Adapter	3-Pole Adapter	WZ12C	Clamp Z3512A	MFLEX P300	CP1100		
R _{INS}	R _{INS} , R _{IE ISO}	1 ... 999 kΩ 1.00 ... 9.99 MΩ 10.0 ... 49.9 MΩ	1 kΩ 10 kΩ 100 kΩ	I _K = 1.5 mA	50 kΩ ... 500 MΩ	U _N = 50 V I _N = 1 mA	kΩ range ±(5% rdg.+10D)	kΩ range ±(3% rdg.+10d)	●	●							
		1 ... 999 kΩ 1.00 ... 9.99 MΩ 10.0 ... 99.9 MΩ	1 kΩ 10 kΩ 100 kΩ			U _N = 100 V I _N = 1 mA											
		1 ... 999 kΩ 1.00 ... 9.99 MΩ 10.0 ... 99.9 MΩ 100 ... 200 MΩ	1 kΩ 10 kΩ 100 kΩ 1 MΩ			U _N = 250 V I _N = 1 mA											
		1 ... 999 kΩ 1.00 ... 9.99 MΩ 10.0 ... 99.9 MΩ 100 ... 500 MΩ	1 kΩ 10 kΩ 100 kΩ 1 MΩ			U _N = 500 V U _N = 1000 V I _N = 1 mA											
U		10 ... 999 V 1.00 ... 1.19 kV	1 V 10 V		10 ... 1.19 kV		±(3% rdg. + 1 d)	±(1.5% rdg. + 1 d)									
R _{LO}	R _{LO}	0.01 Ω ... 9.99 Ω 10.0 Ω ... 199.9 Ω	10 mΩ 100 mΩ	I _m ≥ 200 mA I _m < 200 mA	0.1 Ω ... 5.99 Ω 6.0 Ω ... 100 Ω	U ₀ = 4.5 V	±(4% rdg. + 2 d)	±(2% rdg. + 2 d)	●								
				Transformation ratio ³			5	5									
SENSOR 6 7	I _{L/Amp}	0.0 ... 99.9 mA 100 ... 999 mA 1.00 ... 9.99 A 10.0 ... 15.0 A 1.00 ... 9.99 A 10.0 ... 99.9 A 100 ... 150 A	0.1 mA 1 mA 0.01 A 0.1 A 0.01 A 0.1 A 1 A	1 V/A	5 ... 15 A	f _N = 50/60 Hz	±(13% rdg.+5d)	±(5% rdg.+4d)					I 15A				
		0.0 ... 99.9 mA 100 ... 999 mA 1.00 ... 9.99 A 10.0 ... 99.9 A 100 ... 150 A	0.1 mA 1 mA 0.01 A 0.1 A 1 A	1 mV/A	5 ... 150 A		±(11% rdg.+4d)	±(4% rdg.+3d)							II 150A		
		0.0 ... 99.9 mA 100 ... 999 mA 1.00 ... 9.99 A 10.0 ... 99.9 A 100 ... 150 A	0.1 mA 1 mA 0.01 A 0.1 A 1 A	1 V/A	5 ... 1000 mA	100 mV/A	0.05 ... 10 A	f _N = 16.7/50/60/200/400 Hz	±(7% rdg.+2 d)	±(5% rdg.+2 d)					1 A		
		0.0 ... 99.9 A 0.00 ... 9.99 A 10.0 ... 99.9 A 100 ... 999 A	0.01 A 0.1 A 0.01 A 0.1 A	10 mV/A	0.5 ... 100 A				±(3.4% rdg.+2 d)	±(3% rdg.+2 d)						10 A	
		0.0 ... 99.9 A 10.0 ... 99.9 A 100 ... 999 A	0.01 A 0.1 A 1 A	1 mV/A	5 ... 1000 A				±(3.1% rdg.+2 d)	±(3% rdg.+2 d)						100 A	
		0.0 ... 99.9 A 100 ... 999 A	0.1 A 1 A	1 mV/A	5 ... 1000 A				±(3.1% rdg.+1 d)	±(3% rdg.+1 d)						1000A	
		0.0 ... 99.9 mA 100 ... 999 mA 1.00 ... 9.99 A 10.0 ... 99.9 A 100 ... 999 A	0.1 mA 1 mA 0.01 A 0.1 A 1 A	1 V/A	30 ... 1000 mA	100 mV/A	0.3 ... 10 A	f _N = 50/60 Hz	±(27% rdg.+100 d)	±(3% rdg.+100 d)					0.03		
		0.0 ... 9.99 A 0.00 ... 9.99 A 10.0 ... 99.9 A 100 ... 999 A	0.01 A 0.1 A 0.01 A 0.1 A	10 mV/A	3 ... 100 A				±(27% rdg.+11 d)	±(3% rdg.+11 d)						3	
		0.0 ... 9.99 A 10.0 ... 99.9 A 100 ... 999 A	0.01 A 0.1 A 1 A	10 mV/A	3 ... 100 A				±(27% rdg.+12 d)	±(3% rdg.+12 d)						0.3	
		0.0 ... 9.99 A 10.0 ... 99.9 A 100 ... 999 A	0.01 A 0.1 A 1 A	10 mV/A	0.5 ... 100 A				±(27% rdg.+11 d)	±(3% rdg.+11 d)						30	
		0.0 ... 9.99 A 10.0 ... 99.9 A 100 ... 999 A	0.01 A 0.1 A 1 A	1 mV/A	5 ... 1000 A	1 mV/A	5 ... 1000 A	f _N = DC/16.7/50/60/200 Hz	±(5% rdg.+12 d)	±(3% rdg.+12 d)					100A		
		0.0 ... 9.99 A 10.0 ... 99.9 A 100 ... 999 A	0.01 A 0.1 A 1 A	1 mV/A	5 ... 1000 A				±(5% rdg.+2 d)	±(3% rdg.+2 d)						~	
		0.0 ... 9.99 A 10.0 ... 99.9 A 100 ... 999 A	0.01 A 0.1 A 1 A	1 mV/A	5 ... 1000 A				±(5% rdg.+7 d)	±(3% rdg.+7 d)						1000A	
		0.0 ... 9.99 A 10.0 ... 99.9 A 100 ... 999 A	0.01 A 0.1 A 1 A	1 mV/A	5 ... 1000 A				±(5% rdg.+2 d)	±(3% rdg.+2 d)						~	

1 U > 230 V with 2 or 3-pole adapter only
2 1/2 · IΔN > 300 mA and 5 · IΔN > 500 mA and I_f > 300 mA only up to U_N ≤ 230 V!
3 The transformation ratio selected at the clamp (1 ... 1000 mV/A) must be set in the "Type" menu with the rotary switch in the "SENSOR" position.
4 Where R_{Eselective}/R_{Etotal} < 100

5 the indicated measuring and intrinsic uncertainties already include the uncertainties of the respective current clamp.
6 Measuring range of the signal input at the test instrument U_E: 0 ... 1.0 V_{eff} (0 ... 1.4 V_{peak}) AC/DC
7 Input impedance of signal input at the test instrument: 800 kΩ
8 for f_N < 45 Hz => U_N < 253 V

Special Function MPRO, MXTRA

Function	Measured Quantity	Display Range	Resolution	Test Current/Signal Frequency ⁵	Measuring Range	Measuring Uncertainty	Intrinsic Uncertainty	Connections			
								Adapter for Test Plug PRO-RE	PRO-RE/2	Current Clamps Z3512A	Z591B
RE _{BAT}	RE, 3-pole	0.00 ... 9.99 Ω 10.0 ... 99.9 Ω 100 ... 999 Ω	0.01 Ω 0.1 Ω 1 Ω	16 mA/128 Hz 1.6 mA/128 Hz 0.16 mA/128 Hz	1.00 Ω ... 19.9 Ω 5.0 Ω ... 199 Ω 50 Ω ... 1.99 kΩ	±(10% v.M.+10D) + 1 Ω	±(3% v.M.+5D) + 0.5 Ω	6			
	RE, 4-pole	1.00 ... 9.99 kΩ 10.0 ... 50.0 kΩ	0.01 kΩ 0.1 kΩ	0.16 mA/128 Hz 0.16 mA/128 Hz	0.50kΩ ... 19.9kΩ 0.50kΩ ... 49.9kΩ	±(10% rdg.+10d)	±(3% rdg.+5d)				
	RE, 4-pole Selective With clamp meter	0.00 ... 9.99 Ω 10.0 ... 99.9 Ω 100 ... 999 Ω 1.00 ... 9.99 kΩ ¹⁵ 10.0 ... 19.9 kΩ ¹⁶ 10.0 ... 49.9 kΩ	0.01 Ω 0.1 Ω 1 Ω 0.01 kΩ 0.1 kΩ 0.1 kΩ	16 mA/128 Hz 1.6 mA/128 Hz 0.16 mA/128 Hz 0.16 mA/128 Hz 0.16 mA/128 Hz	1.00 Ω ... 9.99 Ω 10.0 Ω ... 200 Ω	±(15% rdg.+10d) ±(20% rdg.+10d) ¹⁰	±(10% rdg.+10d) ±(15% rdg.+10d)	6		9	
	Soil resistivity (ρ)	0.0 ... 9.9 Ωm 100 ... 999 Ωm 1.00 ... 9.99 kΩm	0.1 Ωm 1 Ωm 0.01 kΩm	16 mA/128 Hz 1.6 mA/128 Hz 0.16 mA/128 Hz 0.16 mA/128 Hz	100 Ωm ... 9.99 kΩm ¹² 500 Ωm ... 9.99 kΩm ¹² 5.00 kΩm ... 9.99 kΩm ¹³ 5.00 kΩm ... 9.99 kΩm ¹³ 5.00 kΩm ... 9.99 kΩm ¹³	±(20% rdg.+10d) ₁₁	±(12% rdg.+10d) ₁₁	6			
	Probe distance d (ρ)	0.1 ... 999 m									
	RE, 2 clamps	0.00 ... 9.99 Ω 10.0 ... 99.9 Ω 100 ... 999 Ω 1.00 ... 1.99 kΩ	0.01 Ω 0.1 Ω 1 Ω 0.01 kΩ	30 V / 128 Hz	0.10 ... 9.99 Ω 10.0 ... 99.9 Ω	±(10% rdg.+5d) ±(20% rdg.+5d)	±(5% rdg.+5d) ±(12% rdg.+5d)		7	9	8

5 Signal frequency without interference signal
6 PRO-RE (Z501S) adapter cable for test plug, for connecting earth probes (E-Set 3/4)
7 PRO-RE/2 (Z502T) adapter cable for test plug, for connecting the generator clamp (E-CLIP2)
8 Generator clamp: E-CLIP2 (Z591B)
9 Clamp meter: Z3512A (Z225A)
10 Where RE.sel/RE < 10 or clamp current > 500 μA
11 Where RE.H/RE ≤ 100 and RE.E/RE ≤ 100
12 Where d = 20 m
13 Where d = 2 m
14 Where Z_{L,PE} < 0.5 Ω, I_k > U_N/0.5 Ω is indicated
15 Only where RANGE = 20 kΩ
16 Only where RANGE = 50 kΩ or AUTO

Key: D = digits, rdg. = measured value (reading)

Characteristic Values PROFITEST MASTER & SECULIFE IP

Reference Conditions

Line voltage	230 V ± 0.1%
Line frequency	50 Hz ± 0.1%
Meas. quantity frequency	45 Hz ... 65 Hz
Measured qty. waveform	Sine (deviation between effective and rectified value ≤ 0.1%)
Line impedance angle	cos φ = 1
Probe resistance	≤ 10 Ω
Supply power	12 V ± 0.5 V
Ambient temperature	+ 23 °C ± 2 K
Relative humidity	40% ... 60%
Finger contact	For testing potential difference to ground potential
Standing surface insulation	Purely ohmic

Nominal Ranges of Use

Voltage U_N	120 V	(108 ... 132 V)
	230 V	(196 ... 253 V)
	400 V	(340 ... 440 V)
Frequency f_N	16 ² / ₃ Hz	(15.4 ... 18 Hz)
	50 Hz	(49.5 ... 50.5 Hz)
	60 Hz	(59.4 ... 60.6 Hz)
	200 Hz	(190 ... 210 Hz)
	400 Hz	(380 ... 420 Hz)
Overall voltage range U_Y	65 ... 550 V	
Overall frequency range	15.4 ... 420 Hz	
Waveform	Sine	
Temperature range	0 °C ... + 40 °C	
Supply voltage	8 ... 12 V	
Line impedance angle	Corresponds to cos φ = 1 ... 0.95	
Probe resistance	< 50 kΩ	

Power Supply

Rechargeable batteries	8 each AA 1.5 V, we recommend eneloop type AA HR6, 2000 mAh (article no. Z502H)
Number of measurements (standard setup with illumination)	
– For R_{INS}	1 measurement – 25 s pause: approx. 1100 measurements
– For R_{LO}	Automatic polarity reversal / 1 Ω (1 measuring cycle) – 25 s pause: approx. 1000 measurements
Battery test	Symbolic display of battery voltage BAT 
Battery saver circuit	Display illumination can be switched off. The test instrument is switched off automatically after the last key operation. The user can select the desired on-time.
Safety shutdown	If supply voltage is too low, the instrument is switched off, or cannot be switched on.
Recharging socket	Installed rechargeable batteries can be recharged directly by connecting a charger to the recharging socket: charger for Z502R
Charging time	Approx. 2 hours *

* Maximum charging time with fully depleted rechargeable batteries. A timer in the charger limits charging time to no more than 4 hours.

Overload Capacity

R_{INS}	1200 V continuous
U_{L-PE}, U_{L-N}	600 V continuous
RCD, R_E, R_F	440 V continuous
Z_{L-PE}, Z_{L-N}	550 V (Limits the number of measurements and pause duration. If overload occurs, the instrument is switched off by means of a thermostatic switch.)
R_{LO}	Electronic protection prevents switching on if interference voltage is present.
Fine-wire fuse protection	FF 3.15 A 10 s, Fuses blow at > 5 A –

Electrical Safety

Protection class	II per IEC 61010-1/EN 61010-1/VDE 0411-1
Nominal voltage	230/400 V (300/500 V)
Test voltage	3.7 kV 50 Hz
Measuring category	CAT III 500 V or CAT IV 300 V
Pollution degree	2
Fusing, L and N terminals	1 cartridge fuse-link ea. FF 3.15/500G 6.3 x 32 mm

Electromagnetic Compatibility (EMC)

Product Standard EN 61326-1:2006

Interference emission		Class
EN 55022		A
Interference immunity	Test Value	Feature
EN 61000-4-2	Contact/atmos. – 4 kV/8 kV	
EN 61000-4-3	10 V/m	
EN 61000-4-4	Mains conn. – 2 kV	
EN 61000-4-5	Mains conn. – 1 kV	
EN 61000-4-6	Mains conn. – 3 V	
EN 61000-4-11	0.5 period / 100%	

Ambient Conditions

Accuracy	0 to + 40 °C
Operation	–5 ... + 50 °C
Storage	–20 ... + 60 °C (without batteries)
Relative humidity	Max. 75%, no condensation allowed
Elevation	Max. 2000 m

Mechanical Design

Display	Multiple display with dot matrix 128 x 128 pixels
Dimensions	W x L x D: 260 x 330 x 90 mm
Weight	approx. 2.7 kg with batteries
Protection	Housing: IP 40, test probe: IP 40 per EN 60529/DIN VDE 0470, part 1

Excerpt from Table on the Meaning of IP Codes

IP XY (1 st digit X)	Protection Against Foreign Object Entry	IP XY (2 nd digit Y)	Protection Against Penetration by Water
4	≥ 1.0 mm dia.	0	Not protected

Data Interfaces

Type	USB slave for PC connection
Type	RS 232 for barcode and RFID scanners
Type	Bluetooth® for connection to a PC (MTECH+, MXTRA & SECULIFE IP only)

20 Maintenance

20.1 Firmware Revision and Calibration Information

See section 4.6.

20.2 Rechargeable Battery Operation, and Charging

Check to make sure that no leakage has occurred at the rechargeable batteries at short, regular intervals, or after the instrument has been in storage for a lengthy period of time.



Note

Prior to lengthy periods of rest (e. g. holiday), we recommend removing the rechargeable batteries. This helps to prevent excessive depletion or leakage of batteries, which, under unfavourable circumstances, may cause damage to the instrument.

If battery voltage has fallen below the allowable lower limit, the pictograph shown at the right appears. "Low Batt!!!" is also displayed along with a battery icon. The instrument does not function if the batteries have been depleted excessively, and no display appears.

BAT



Attention!

Use only the charger Z502R to charge the **Kompakt Akku-Pack Master (Z502H)** which has already been inserted into the test instrument.

Make sure that the following conditions have been fulfilled before connecting the charger to the charging socket:

- Kompakt Akku-Pack Master (Z502H) has been installed, no commercially available battery packs, no individual rechargeable batteries, no standard batteries
- The test instrument has been disconnected from the measuring circuit at all poles
- The instrument must remain off during charging.

If the batteries or the battery pack (Z502H) have not been used or recharged for a lengthy period of time (> one month), thus resulting in excessive depletion:

Observe the charging sequence (indicated by LEDs at the charger) and initiate a second charging sequence if necessary (disconnect the charger from the mains and from the test instrument to this end, and then reconnect it). Please note that the system clock stops in this case and must be set to the correct time after the instrument has been restarted.

20.2.1 Charging Procedure with Charger for Z502R

- ⇨ Insert the correct mains plug for your country into the charger.



Attention!

Make sure that **Kompakt Akku Pack Master (Z502H)** has been inserted, no battery holder.

For charging in the tester, only use Kompakt Akku Pack Master (Z502H), which is either included in the standard equipment or available as an accessory, with heat-sealed battery cells.

- ⇨ Connect the charger to the test instrument with the jack plug, and then to the 230 V mains with the interchangeable plug. (The charger is suitable for mains operation only!)



Attention!

Do not switch the test instrument on during charging. Monitoring of the charging process by the microprocessor might otherwise be disturbed, in which case the charging times specified in the technical data can no longer be assured.

- ⇨ Please refer to the operating instructions included with the charger regarding the meanings of LED displays during the charging process.
- ⇨ Do not disconnect the charger from the test instrument until the green LED (charged/ready) lights up.

20.3 Fuses

If a fuse has blown due to overload, a corresponding message error appears at the display panel. The instrument's voltage measuring ranges are nevertheless still functional.

Replacing the Fuse



Attention!

Disconnect the device from the measuring circuit at all poles before opening the fuse compartment lid!

- ⇨ Loosen the slotted screws at the fuse compartment lid next to the mains power cable with a screwdriver. The fuses are now accessible.
- ⇨ Replacement fuses can be accessed after opening the battery compartment lid.



Attention!

Severe damage to the instrument may occur if incorrect fuses are used.

Only original fuses from GMC-I Messtechnik GmbH may be used (order no. 3-578-285-01 / SIBA 7012540.3.15 SI-EINSATZ FF 3.15/500 6.3X32).

Only original fuses assure required protection by means of suitable blowing characteristics. Short-circuiting of fuse terminals or the repair of fuses is prohibited, and is life endangering!

The instrument may be damaged if fuses with incorrect ampere ratings, breaking capacities or blowing characteristics are used!

- ⇨ Remove the defective fuse and insert a new one.
- ⇨ Insert the fuse compartment lid after the fuse has been replaced and secure it by turning clockwise.

20.4 Housing

No special maintenance is required for the housing. Keep outside surfaces clean. Use a slightly dampened cloth for cleaning. In particular for the protective rubber surfaces, we recommend a moist, lint-free microfiber cloth. Avoid the use of cleansers, abrasives or solvents.

Return and Environmentally Sound Disposal

The **instrument** is a category 9 product (monitoring and control instrument) in accordance with ElektroG (German electrical and electronic device law). This device is subject to the RoHS directive. Furthermore, we make reference to the fact that the current status in this regard can be accessed on the Internet at www.gossenmetrawatt.com by entering the search term WEEE.

In accordance with WEEE 2012/19EU and ElektroG, we identify our electrical and electronic devices with the symbol in accordance with DIN EN 50419 which is shown at the right. Devices identified with this symbol may not be disposed of with the trash. Please contact our service department regarding the return of old devices (see address in section 22).



If the **(rechargeable) batteries** used in your instrument are depleted, they must be disposed of properly in accordance with valid national regulations.

Batteries may contain pollutants and heavy metals such as lead (Pb), cadmium (Cd) and mercury (Hg).

The symbol to the right indicates that batteries must not be disposed of with the trash, and must be brought to a designated collection point.



Pb Cd Hg

21 Appendix

21.1 Tables for the determination of maximum or minimum display values under consideration of maximum measuring uncertainty:

Table 1

$Z_{L-PE} \text{ (full wave)} / Z_{L-N}$ (Ω)		$Z_{L-PE} \text{ (+/- half-wave)}$ (Ω)	
Limit Value	Max. Display Value	Limit Value	Max. Display Value
0.10	0.07	0.10	0.05
0.15	0.11	0.15	0.10
0.20	0.16	0.20	0.14
0.25	0.20	0.25	0.18
0.30	0.25	0.30	0.22
0.35	0.30	0.35	0.27
0.40	0.34	0.40	0.31
0.45	0.39	0.45	0.35
0.50	0.43	0.50	0.39
0.60	0.51	0.60	0.48
0.70	0.60	0.70	0.56
0.80	0.70	0.80	0.65
0.90	0.79	0.90	0.73
1.00	0.88	1.00	0.82
1.50	1.40	1.50	1.33
2.00	1.87	2.00	1.79
2.50	2.35	2.50	2.24
3.00	2.82	3.00	2.70
3.50	3.30	3.50	3.15
4.00	3.78	4.00	3.60
4.50	4.25	4.50	4.06
5.00	4.73	5.00	4.51
6.00	5.68	6.00	5.42
7.00	6.63	7.00	6.33
8.00	7.59	8.00	7.24
9.00	8.54	9.00	8.15
9.99	9.48	9.99	9.05

Table 3

$R_{INS} \text{ M}\Omega$			
Limit Value	Min. Display Value	Limit Value	Min. Display Value
0.10	0.12	10.0	10.7
0.15	0.17	15.0	15.9
0.20	0.23	20.0	21.2
0.25	0.28	25.0	26.5
0.30	0.33	30.0	31.7
0.35	0.38	35.0	37.0
0.40	0.44	40.0	42.3
0.45	0.49	45.0	47.5
0.50	0.54	50.0	52.8
0.55	0.59	60.0	63.3
0.60	0.65	70.0	73.8
0.70	0.75	80.0	84.4
0.80	0.86	90.0	94.9
0.90	0.96	100	106
1.00	1.07	150	158
1.50	1.59	200	211
2.00	2.12	250	264
2.50	2.65	300	316
3.00	3.17		
3.50	3.70		
4.00	4.23		
4.50	4.75		
5.00	5.28		
6.00	6.33		
7.00	7.38		
8.00	8.44		
9.00	9.49		

Table 2

$R_E / R_{Loop} \text{ } (\Omega)$					
Limit Value	Max. Display Value	Limit Value	Max. Display Value	Limit Value	Max. Display Value
0.10	0.07	10.0	9.49	1.00 k	906
0.15	0.11	15.0	13.6	1.50 k	1.36 k
0.20	0.16	20.0	18.1	2.00 k	1.81 k
0.25	0.20	25.0	22.7	2.50 k	2.27 k
0.30	0.25	30.0	27.2	3.00 k	2.72 k
0.35	0.30	35.0	31.7	3.50 k	3.17 k
0.40	0.34	40.0	36.3	4.00 k	3.63 k
0.45	0.39	45.0	40.8	4.50 k	4.08 k
0.50	0.43	50.0	45.4	5.00 k	4.54 k
0.60	0.51	60.0	54.5	6.00 k	5.45 k
0.70	0.60	70.0	63.6	7.00 k	6.36 k
0.80	0.70	80.0	72.7	8.00 k	7.27 k
0.90	0.79	90.0	81.7	9.00 k	8.17 k
1.00	0.88	100	90.8	9.99 k	9.08 k
1.50	1.40	150	133		
2.00	1.87	200	179		
2.50	2.35	250	224		
3.00	2.82	300	270		
3.50	3.30	350	315		
4.00	3.78	400	360		
4.50	4.25	450	406		
5.00	4.73	500	451		
6.00	5.68	600	542		
7.00	6.63	700	633		
8.00	7.59	800	724		
9.00	8.54	900	815		

Table 4

$R_{LO} \text{ } \Omega$			
Limit Value	Max. Display Value	Limit Value	Max. Display Value
0.10	0.07	10.0	9.59
0.15	0.12	15.0	14.4
0.20	0.17	20.0	19.2
0.25	0.22	25.0	24.0
0.30	0.26	30.0	28.8
0.35	0.31	35.0	33.6
0.40	0.36	40.0	38.4
0.45	0.41	45.0	43.2
0.50	0.46	50.0	48.0
0.60	0.55	60.0	57.6
0.70	0.65	70.0	67.2
0.80	0.75	80.0	76.9
0.90	0.84	90.0	86.5
1.00	0.94	99.9	96.0
1.50	1.42		
2.00	1.90		
2.50	2.38		
3.00	2.86		
3.50	3.34		
4.00	3.82		
4.50	4.30		
5.00	4.78		
6.00	5.75		
7.00	6.71		
8.00	7.67		
9.00	8.63		

Table 5

Z _{ST} kΩ	
Limit Value	Min. Display Value
10	14
15	19
20	25
25	30
30	36
35	42
40	47
45	53
50	58
56	65
60	69
70	80
80	92
90	103
100	114
150	169
200	253
250	315
300	378
350	440
400	503
450	565
500	628
600	753
700	878
800	>999

Table 6

Short-Circuit Current Minimum Display Values

for the determination of nominal current for various fuses and breakers for systems with nominal voltage of U_N = 230 V

Nominal Current I _N [A]	Low Resistance Fuses per DIN VDE 0636 series of standards Characteristic gL, gG, gM				With Circuit Breaker and Line Switch							
	Breaking Current I _A 5 s		Breaking Current I _A 0.4 s		Characteristic B/E (formerly L) Breaking Current I _A 5 x I _N (< 0.2 s/0.4 s)		Characteristic C (formerly G, U) Breaking Current I _A 10 x I _N (< 0.2 s/0.4 s)		Characteristic D Breaking Current I _A 20 x I _N (< 0.2 s/0.4 s)		Characteristic K Breaking Current I _A 12 x I _N (< 0.1 s)	
	Limit Value [A]	Min. Display [A]	Limit Value [A]	Min. Display [A]	Limit Value [A]	Min. Display [A]	Limit Value [A]	Min. Display [A]	Limit Value [A]	Min. Display [A]	Limit Value [A]	Min. Display [A]
	2	9.2	10	16	17	10	11	20	21	40	42	24
3	14.1	15	24	25	15	16	30	32	60	64	36	38
4	19	20	32	34	20	21	40	42	80	85	48	51
6	27	28	47	50	30	32	60	64	120	128	72	76
8	37	39	65	69	40	42	80	85	160	172	96	102
10	47	50	82	87	50	53	100	106	200	216	120	128
13	56	59	98	104	65	69	130	139	260	297	156	167
16	65	69	107	114	80	85	160	172	320	369	192	207
20	85	90	145	155	100	106	200	216	400	467	240	273
25	110	117	180	194	125	134	250	285	500	578	300	345
32	150	161	265	303	160	172	320	369	640	750	384	447
35	173	186	295	339	175	188	350	405	700	825	420	492
40	190	205	310	357	200	216	400	467	800	953	480	553
50	260	297	460	529	250	285	500	578	1000	1.22 k	600	700
63	320	369	550	639	315	363	630	737	1260	1.58 k	756	896
80	440	517									960	1.16 k
100	580	675									1200	1.49 k
125	750	889									1440	1.84 k
160	930	1.12 k									1920	2.59 k

Example

Display value 90.4 A → next smaller value for circuit breaker characteristic B from table: 85 A → protective device nominal current (I_N) max. 16 A

21.2 At which values should/must an RCD actually be tripped? Requirements for Residual Current Devices (RCDs)

General Requirements

- Tripping must occur no later than upon occurrence of rated residual current (nominal differential current $I_{\Delta N}$).

and

- Maximum time to trip may not be exceeded.

Additional requirements due to influences on the tripping current range and the point in time of tripping which have to be taken into consideration:

- Residual current type or waveform:
This results in a reliable tripping current range.
- Mains type and line voltage:
This results in maximum tripping time.
- RCD variant (standard or selective):
This results in maximum tripping time.

Definitions of Requirements in the Standards

VDE 0100, part 600, which is included in all German standards collections for **electricians**, applies to measurements in electrical systems. It plainly states: "The effectiveness of the protective measure is substantiated when shut-down occurs no later than upon occurrence of rated differential current $I_{\Delta N}$."

As a requirement for the **measuring instrument manufacturer**, **DIN EN 61557-6 (VDE 0413, part 6)** unmistakably specifies:

"The measuring instrument must be capable of substantiating the fact that the residual current which trips the residual current device (RCD) is less than or equal to rated residual current."





Comment

For all electricians, this means that during scheduled protective measures testing after system modifications or additions to the system, as well as after repairs or during the E-check conducted after measurement of contact voltage, the trip test must be conducted no later than upon reaching a value of, depending upon the RCD, 10, 30, 100, 300 or 500 mA

How does the electrician react in the event that these values are exceeded? The RCD is replaced!

If it was relatively new, a complaint is submitted to the manufacturer. And in his laboratory he determines: The RCD complies with the manufacturer's standard and is OK.

A look at the VDE 0664-10/-20/-100/-200 manufacturer's standard shows us why:

Type of Residual Current	Residual Current Waveform	Allowable Tripping Current Range
Sinusoidal alternating current		0.5 ... 1 $I_{\Delta N}$
Pulsating direct current (positive or negative half-waves)		0.35 ... 1.4 $I_{\Delta N}$
Phase angle controlled half-wave currents Phase angle of 90° el Phase angle of 135° el		0.25 ... 1.4 $I_{\Delta N}$ 0.11 ... 1.4 $I_{\Delta N}$
Pulsating direct current superimposed with 6 mA smooth, direct residual current		Max. 1.4 $I_{\Delta N}$ + 6 mA
Smooth direct current		0.5 ... 2 $I_{\Delta N}$

Because the current waveform plays a significant role, the current waveform used by the test instrument is also important.

Set residual current type or waveform at the test instrument:

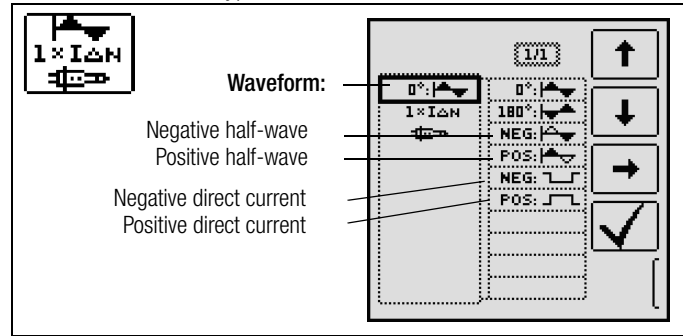

It's important to be able to select and take advantage of the corresponding settings at one's own test instrument.

The situation is similar for breaking times. The new **VDE 0100 part 410**, should also be included in the standards collection. Depending upon mains type and line voltage, it specifies breaking times ranging from 0.1 to 5 seconds.

System	50 V < U ₀ ≤ 120 V		120 V < U ₀ ≤ 230 V		230 V < U ₀ ≤ 400 V		U ₀ > 400 V	
	AC	DC	AC	DC	AC	DC	AC	DC
TN	0.8 s		0.4 s	5 s	0.2 s	0.4 s	0.1 s	0.1 s
TT	0.3 s		0.2 s	0.4 s	0.07 s	0.2 s	0.04 s	0.1 s

RCDs usually interrupt more quickly, but in some cases they can take a bit longer. Once again, the ball is in the manufacturer's court.

The following table is also included in **VDE 0664**:

Variant	Residual Current Type	Breaking Time at			
	Alternating residual current	1 x $I_{\Delta N}$	2 x $I_{\Delta N}$	5 x $I_{\Delta N}$	500 A
	Pulsating direct residual current	1.4 x $I_{\Delta N}$	2 x 1.4 x $I_{\Delta N}$	5 x 1.4 x $I_{\Delta N}$	500 A
	Smooth, direct residual current	2 x $I_{\Delta N}$	2 x 2 x $I_{\Delta N}$	5 x 2 x $I_{\Delta N}$	500 A
Standard (undelayed) or briefly delayed		300 ms	Max. 0.15 s	Max. 0.04 s	Max. 0.04 s
Selective		0.13 ... 0.5 s	0.06 ... 0.2 s	0.05 ... 0.15 s	0.04 ... 0.15 s

Two limit values are highly conspicuous:

- Standard Max. 0.3 s
- Selective Max. 0.5 s

All of the limit values are already included in good test instruments, or it's possible to enter them directly and they're displayed as well!

Select or set limit values at the test instrument:

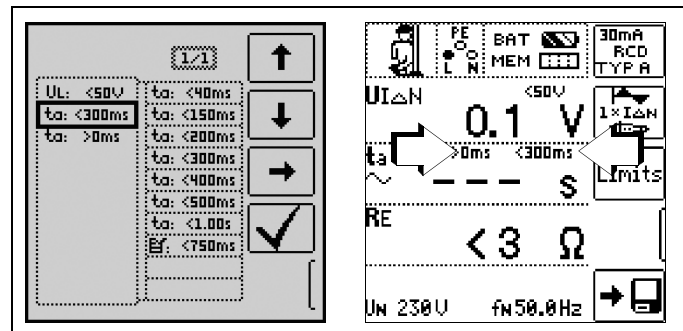

Tests for electrical systems include “visual inspection”, “testing” and “measurement”, and thus may only be conducted by experts with appropriate work experience.

In the final analysis, the values from VDE 0664 are technically binding.

21.3 Testing Electrical Machines per DIN EN 60204 – Applications, Limit Values

The PROFITEST 204+ test instrument has been developed for the testing of electrical machines and controllers. After a revision to the standard in 2007, measurement of loop impedance is now additionally required. Measurement of loop impedance, as well as other measurements required for the testing of electrical machines, can be performed with test instruments from the PROFITEST MASTER series.

Comparison of Tests Specified by the Standards

Tests per DIN EN 60204, part 1 (machines)	Tests per DIN EN 61557 (systems)	Meas. Function
Uninterrupted connection of a protective conductor	Part 4: resistance of: – Ground conductor – Protective conductor – Bonding conductor	RLO
Loop impedance	Part 3: loop impedance	ZL-PE
Insulation resistance	Part 2: insulation resistance	RINS
Voltage test (test for absence of voltage)	—	—
Voltage measurement (protection against residual voltage)	Part 10: Combined measuring equipment (amongst others for voltage measurement) for testing, measuring or monitoring of protective measures	U
Function test	—	—

Uninterrupted Connection of a Protective Conductor

Uninterrupted connection of a protective conductor system is tested here by using an alternating current of 0.2 to 10 A with a line frequency of 50 Hz (= low-resistance measurement). Testing must be conducted between the PE terminal and various points within the protective conductor system.

Loop Impedance Measurement

Loop impedance Z_{L-PE} is measured and short-circuit current I_K is ascertained in order to determine if the breaking requirements for protective devices have been fulfilled (see section 8).

Insulation Resistance Measurement

All of the active conductors in the primary circuit are short-circuited at the machine (L and N, or L1, L2, L3 and N) and measured against PE (protective conductor). Controllers or machine components which are not laid out for these voltages (500 V DC) can be disconnected from the measuring circuit for the duration of the measurement. The measured value may not be any less than 1 MΩ. The test can be subdivided into separate segments.

Voltage Tests (with PROFITEST 204HP/HV only)

The electrical equipment of the machine under test must withstand a test voltage of twice its own rated voltage value or 1000 V~ (whichever is largest) applied between the conductors of all circuits and the protective conductor system for a period of at least 1 second. The test voltage must have a frequency of 50 Hz, and must be generated by a transformer with a minimum power rating of 500 VA.

Voltage Measurement

The EN 60204 standard specifies that after switching supply power off, residual voltage must drop to a value of 60 V or less within 5 seconds at all accessible, active components of a machine to which a voltage of greater than 60 V is applied during operation.

Function Test

The machine is operated with nominal voltage and tested for correct functioning, in particular with regard to safety functions.

Special Tests

- Pulse control mode for troubleshooting (with PROFITEST 204HP/HV only)
- Protective conductor test with 10 A test current (with PROFITEST 204+ only)

Limit Values per DIN EN 60204, Part 1

Measurement	Parameter	Cross-Section	Standard Value
Protective conductor measurement	Test Duration		10 s
	Limit value for protective conductor resistance based on phase conductor cross-section and characteristics of the overvoltage protection device (calculated value)	1.5 mm ²	500 mΩ
		2.5 mm ²	500 mΩ
		4.0 mm ²	500 mΩ
		6.0 mm ²	400 mΩ
		10 mm ²	300 mΩ
		16 mm ²	200 mΩ
		25 mm ² L (16 mm ² PE)	200 mΩ
		35 mm ² L (16 mm ² PE)	100 mΩ
		50 mm ² L (25 mm ² PE)	100 mΩ
70 mm ² L (35 mm ² PE)		100 mΩ	
Insulation resistance measurement	Nominal voltage		500 V DC
	Resistance limit value		≥ 1 MΩ
Leakage current measurement	Leakage current		2.0 mA
Voltage measurement	Discharge time		5 s
Voltage test	Test duration		1 s
	Test voltage		≥ 1 kV or 2 U _N

Overvoltage Protection Device Characteristics for Limit Value Selection for Protective Conductor Testing

Breaking Time, Characteristics	Available for Cross-Section
Fuse breaking time: 5 s	All cross-sections
Fuse breaking time: 0.4 s	1.5 through 16 sq. mm
Circuit breaker, characteristic B $I_a = 5 \times I_n$ – breaking time: 0.1 s	1.5 through 16 sq. mm
Circuit breaker, characteristic C $I_a = 10 \times I_n$ – breaking time: 0.1 s	1.5 through 16 sq. mm
Adjustable circuit breaker $I_a = 8 \times I_n$ – break time: 0.1 s	All cross-sections

21.4 Periodic Testing per DGUV provision 3 (previously BGV A3) – Limit Values for Electrical Systems and Operating Equipment

Limit Values per DIN VDE 0701-0702

Maximum Allowable Limit Values for **Protective Conductor Resistance** for Connector Cables with Lengths of up to 5 m

Test Standard	Test Current	Open-Circuit Voltage	R_{SL} Housing – Mains Plug
VDE 0701-0702:2008	> 200 mA _{AC}	4 V < U_L < 24 V	0.3 Ω ¹ + 0.1 Ω ² for each additional 7.5 m

¹ This value may not exceed 1 Ω for permanently connected data processing systems (DIN VDE 0701-0702).

² Total protective conductor resistance of max. 1 Ω

Minimum Allowable Limit Values for **Insulation Resistance**

Test Standard	Test Voltage	RINS			
		PC I	PC II	PC III	Heating
VDE 0701-0702:2008	500 V	1 M Ω	2 M Ω	0.25 M Ω	0.3 M Ω *

* With activated heating elements (if heating power > 3.5 kW and RINS < 0.3 M Ω : leakage current measurement is required)

Maximum Allowable Limit Values for **Leakage Current** in mA

Test Standard	I_{PE}	I_C	I_{DI}
VDE 0701-0702:2008	SC I: 3.5 1 mA/kW *	0.5	SC I: 3.5 1 mA/ kW * SC II: 0.5

* For devices with heating power of greater than 3.5 kW

Note 1: Devices which are not equipped with accessible parts that are connected to the protective conductor, and which comply with requirements for housing leakage current and, if applicable, patient leakage current, e.g. computer equipment with shielded power pack

Note 2: Permanently connected devices with protective conductor

Note 3: Portable x-ray devices with mineral insulation

Key

I_B Housing leakage current (probe or contact current)

I_{DI} Residual current

I_{SL} Protective conductor current

Maximum Allowable Limit Values for **Equivalent Leakage Current** in mA

Test Standard	I_{EL}
VDE 0701-0702:2008	SC I: 3.5 1 mA/kW ¹ SC II: 0.5

¹ For devices with heating power \geq 3.5 kW

21.5 List of Abbreviations and their Meanings

RCCBs (residual current devices / RCDs)

I_{Δ}	Tripping current
$I_{\Delta N}$	Nominal residual current
$I_{F\blacktriangleleft}$	Rising test current (residual current)
PRCD	Portable residual current device
	PRCD-S: with protective conductor detection and monitoring
	PRCD-K: with undervoltage trigger and protective conductor monitoring

RCD-S Selective RCCB

R_E	Calculated earthing or earth electrode loop resistance
SRCD	Socket residual current device (permanently installed)
t_a	Time to trip / breaking time
$U_{I\Delta}$	Contact voltage at moment of tripping
$U_{I\Delta N}$	Contact voltage relative to nominal residual current $I_{\Delta N}$
U_L	Contact voltage limit value

Overcurrent Protective Devices

I_K	Calculated short-circuit current (at nominal voltage)
Z_{L-N}	Line impedance
Z_{L-PE}	Loop impedance

Earthing

R_B	Operational earth resistance
R_E	Measured earthing resistance
$R_{E\text{Loop}}$	Earth electrode loop resistance

Low-Value Resistance at Protective, Earthing and Bonding Conductors

R_{LO+}	Bonding conductor resistance (+ pole to PE)
R_{LO-}	Bonding conductor resistance (- pole to PE)

Insulation

$R_{E(\text{ISO})}$	Earth leakage resistance (DIN 51 953)
R_{INS}	Insulation resistance
R_{ST}	Standing surface insulation resistance
Z_{ST}	Standing surface insulation impedance

Current

I_A	Breaking current
I_L	Leakage current (measured with current clamp transformer)
I_M	Measuring current
I_N	Nominal current
I_P	Test current

Voltage

f	Line voltage frequency
f_N	Nominal voltage rated frequency
ΔU	Voltage drop as %
U	Voltage measured at the test probes during and after insulation measurement R_{INS}
U_{Batt}	Battery voltage
U_E	Earth electrode voltage
U_{INS}	For measurement of R_{INS} : test voltage, for ramp function: triggering or breakdown voltage
U_{L-L}	Voltage between two phase conductors
U_{L-N}	Voltage between L and N
U_{L-PE}	Voltage between L and PE
U_N	Nominal line voltage
U_{3-}	Highest measured voltage during determination of phase sequence
U_{S-PE}	Voltage between probe and PE
U_Y	Conductor voltage to earth

21.6 Keyword Index

A			
Abbreviations	93	PRCDs with PROFITEST PRCD Adapter	62
Adjusting Brightness and Contrast	10	PRCD-K	22
B		PRCD-S	23
Batteries		Profiles for Distributor Structures (PROFILES)	10
Charge Level	3	R	
Installation	7	RCD-S	22
Battery		Residual voltage test	58
Test	7	S	
Bibliography	95	SCHUKOMAT	23
Bluetooth Active Display	3	Select System Type (TN, TT, IT)	25
C		short-circuit current	29
Contact Voltage	19	Short-circuit current Calculation	28
Current Clamp Sensor		SIDOS	23
Measuring Range	35, 40, 41, 50	SRCD	23
D		Standard	
Data Backup	7	DIN EN 50178 (VDE 160)	21
DB MODE	11	DIN EN 60 204	91
DB-MODE	11	DIN VDE 0100	26, 32
Default Settings (GOME SETTING)	10	DIN VDE 0100, Part 410	22
E		DIN VDE 0100, Part 600	5
Earth Electrode Loop Resistance	34	DIN VDE 0100, Part 610	20, 27
Earth Electrode Voltage	34	EN 1081	46
Earth Fault Detection Systems	56	IEC 61851	61
Earth Leakage Resistance	46	NIV/NIN SEV 1000	5, 34
Earthing Resistance Measurement		ÖVE/ÖNORM E 8601	24
Overview	31	ÖVE-EN 1	5
Electric charging stations	61	VDE 0413	18, 26, 30
Electric vehicles	61	Standing Surface Insulation Impedance	51, 53
F		Switching Bluetooth On/Off	11
Firmware Revision and Calibration Information	12	Symbol	6
Firmware Update	12	T	
Fuse		Test sequences	64
Replacement	87	Testing	
I		BGVA3	92
Insulation Monitoring Devices	56	Electrical Machines	91
Interfaces		Type G RCCB	24
Configuring Bluetooth	11	U	
USB, RS 232 Ports	2	User Interface Language (CULTURE)	10
Internet Addresses	95	V	
L		Voltage Drop as % (ZL-N function)	52
LCD Illumination		W	
On-Time	10	warranty seal	7
Limit Values			
DINEN 60204, Part 1	91		
DINVDE0701-0702	92		
Line Voltage (display of UL-N)	29		
Line-to-Line Voltage	17		
M			
MASTER Updater	12		
Memory			
Occupancy Display	3		
MENNEKES test box	61		
N			
Non-Tripping Test	21		
O			
On-Time			
Test Instrument	10		
P			
Parameter Lock	14		
Phase Sequence	17		
Plausibility Check	14		
Polarity Reversal	15		
PRCD			
Test Sequences for Report Generation of Fault Simulations on			

21.7 Bibliography

Statutory Source Documents			
German occupational safety legislation (BetrSichV) Regulations issued by the accident insurance carriers			
Title	Information Rule / Regulation	Publisher	Issue / Order No.
Betriebs Sicherheits Verordnung (BetrSichV)	BetrSichV		
Elektrische Anlagen und Betriebsmittel	DGUV provision 3 (up to now BGV A3)	DGUV (up to now HVBG)	2005

VDE Standards			
German standard	Title	Date of Issue	Publisher
DIN VDE 0100-410	Protection against electric shock	2007-06	Beuth-Verlag GmbH
DIN VDE 0100-530	Erection of low-voltage installations Part 530: Selection and erection of electrical equipment - Switchgear and controlgear	2011-06	Beuth-Verlag GmbH
DIN VDE 0100-600	Erection of low-voltage installations Part 6: Tests	2008-06	Beuth-Verlag GmbH
Series of standards DIN EN 61557	Devices for testing, measuring or monitoring protective measures	2006-08	Beuth-Verlag GmbH
DIN VDE 0105-100	Operation of electrical installations, part 100: General requirements	2009-10	Beuth-Verlag GmbH
VDE 0122-1 DIN EN 61851-1	Electric vehicle conductive charging system - Part 1: General requirements (IEC 61851-1:2012)	2013-04	Beuth-Verlag GmbH

21.7.1 Internet Addresses for Additional Information

Internet Address	
www.dguv.de	GUV information, rules and regulations from Deutsche Gesetzliche Unfallversicherung e.V.
www.beuth.de	VDE regulations, DIN standards, VDI directives from Beuth-Verlag GmbH
www.bgetf.de	BG information, rules and regulations from gewerbliche Berufsgenossenschaften e.g. BG ETEM (trade association for energy, textiles, electrical, Medienezeugnisse)

22 Repair and Replacement Parts Service Calibration Center* and Rental Instrument Service

If required please contact:

GMC-I Service GmbH
Service-Center
Thomas-Mann-Strasse 16-20
90471 Nürnberg, Germany
Phone: +49 911 817718-0
Fax: +49 911 817718-253
E-mail service@gossenmetrawatt.com
www.gmci-service.com

This address is only valid in Germany. Please contact our representatives or subsidiaries for service in other countries.

* **DAkkS Calibration Laboratory for Electrical Quantities**
D-K-15080-01-01 accredited per DIN EN ISO/IEC 17025

Accredited quantities: direct voltage, direct current value, direct current resistance, alternating voltage, alternating current value, AC active power, AC apparent power, DC power, capacitance, frequency and temperature

Competent Partner

GMC-I Messtechnik GmbH is certified in accordance with DIN EN ISO 9001.

Our DAkkS calibration laboratory is accredited by the Deutsche Akkreditierungsstelle GmbH (German accreditation body) under registration number D-K-15080-01-01 in accordance with DIN EN ISO/IEC 17025.

We offer a complete range of expertise in the field of metrology: from **test reports** and **proprietary calibration certificates** right on up to **DAkkS calibration certificates**.

Our spectrum of offerings is rounded out with free **test equipment management**.

An **on-site DAkkS calibration station** is an integral part of our service department. If errors are discovered during calibration, our specialized personnel are capable of completing repairs using original replacement parts.

As a full service calibration laboratory, we can calibrate instruments from other manufacturers as well.

23 Recalibration

The measuring tasks performed with your instrument, and the stressing it's subjected to, influence aging of its components and may result in deviation from the specified levels of accuracy.

In the case of strict measuring accuracy requirements, as well as in the event of use at construction sites with frequent stress due to transport and considerable temperature fluctuation, we recommend a relatively short calibration interval of once per year. If your instrument is used primarily in the laboratory and indoors without considerable climatic or mechanical stressing, a calibration interval of once every 2 to 3 years is sufficient as a rule.

During recalibration at an accredited calibration laboratory (DIN EN ISO/IEC 17025), deviations from traceable standards demonstrated by your measuring instrument are documented. Ascertained deviations are used to correct displayed values during later use of the instrument.

We would be happy to perform DAkkS or factory calibration for you at our calibration laboratory. Further information is available at our website:

www.gossenmetrawatt.com (→ Company → DAkkS Calibration Center or → FAQs → Questions and Answers Regarding Calibration).

Recalibration of your instrument at regular intervals is essential for the fulfillment of requirements according to quality management systems per DIN EN ISO 9001.

* Examination of the specification, as well as adjustment, are not included in calibration. However, in the case of our own products, any required adjustment is performed and adherence to the specification is confirmed.

24 Product Support

If required please contact:

GMC-I Messtechnik GmbH
Product Support Hotline
Phone: +49-911 8602-0
Fax: +49 911 8602-709
E-mail: support@gossenmetrawatt.com